

SHELFASST 8B

6FT WIDE BARN INSTRUCTIONS

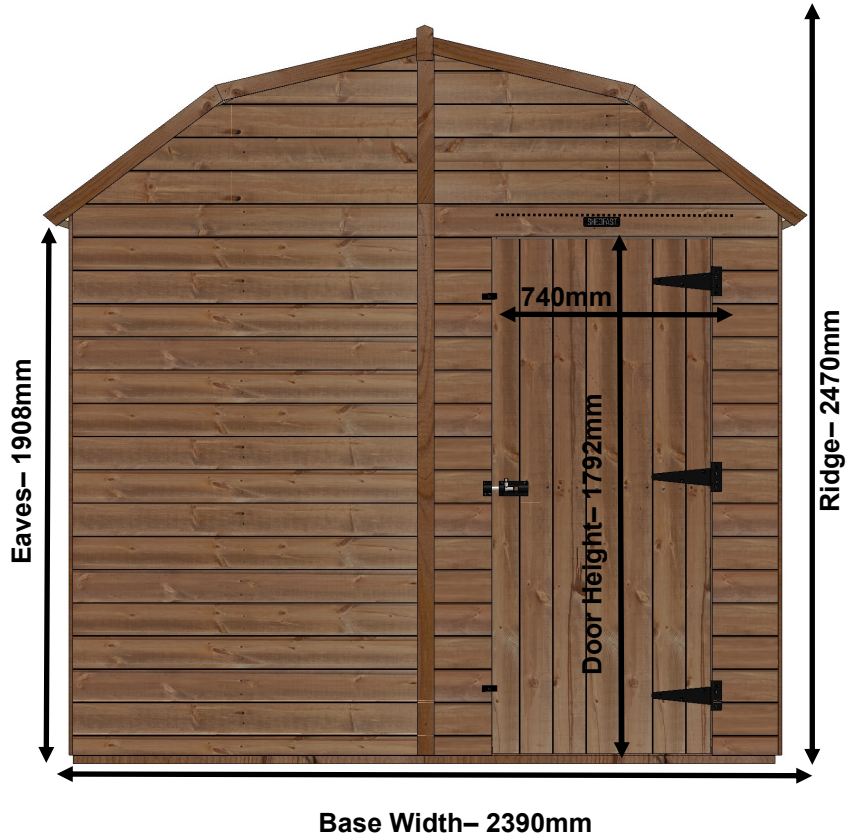

	<u>Width (mm)</u>	<u>Length (mm)</u>
<u>8x6</u>	2390mm	1878mm
<u>8x8</u>		2478mm
<u>8x10</u>		3078mm
<u>8x12</u>		3668mm
<u>8x14</u>		4224mm



Introduction

Warranty -

Your Shedfast shed is guaranteed for two years against faulty manufacture as long as you treat it within two weeks of assembly with our recommended treatment. The guarantee would supply replacement planks or parts for any defective items (ie rarely a full panel) for self installation. Wind damage, non-domestic use, accidental or deliberate damage and Labour are all excluded from the guarantee.

Care and Maintenance-

Your Shedfast shed is made from good quality Scandinavian timber and should give you years of reliable use. However it is important to be aware of the natural properties of wood and accept these changes as they crop up on your shed. This kind of timber is affected by humidity which expands the timber as it gets wetter and shrinks it as it dries out. For this reason it is highly beneficial to treat your shed immediately when it is assembled with a good quality wood treatment. We offer the Shedfast original larch colour in a 2.5l can and you should use this if you want to keep a similar colour to the original. Alternatively, if you want to paint your new building in a coloured finish, then we offer the Protek Royal exterior which is a superb quality coating.

Although your shed comes with a factory applied premium protector treatment, the benefits of hand painting the shed immediately with one of our recommended treatments are so profound that we will only activate the 2 year warranty if your shed is coated with one of our recommended treatments within 2 weeks of assembly.

Please be aware that timber is a natural product and can split, warp, cup, expand and contract, leech sap, shed knots, shake and twist. These matters can be mitigated by applying a treatment immediately when you get your shed and by filling shakes, splits and knot holes as they crop up as a part of your ongoing maintenance. Check your shed annually and fill any defects that have developed.

Safety information-

- Glass and timber can potentially cause injury. Please ensure you wear protective goggles, gloves, headgear and suitable footwear when assembling the building.
- Please remember that glass is fragile and should be handled with extreme care. Always clear up and dispose of any breakages immediately.
- Do not assemble the shed in high winds.
- For safety reasons and ease of assembly when self-assembling, we recommend that this shed is assembled by two people.
- Please clear all lying snow from the shed roof as it can cause the roof to buckle or collapse.
- Please do not stand directly or put your whole body weight on the roof.

Site preparation-

- When selecting a site for your shed, it is vital that you choose as flat and level an area as possible.
- A concrete or slabbed base will provide the most solid foundation for your shed. It is important the base is level.
- Avoid placing your shed under trees or in other vulnerable locations if possible.
- To minimise the risk of wind damage, try to select as sheltered a site as possible, e.g. beside a hedgerow or garden fence.

Tools required-

- Drill
- Spirit Level
- Knife
- Ladders
- Hammer
- Screwdriver
- Tape Measure

Pre Assembly

- Before you start, check you have all the correct components required for the build. See the tables on the back pages to check this.
- Remove any of the transit blocks, but be careful when laying the panels down to not snap any of the over-hanging cladding.

Doors-

Always use the turn buttons to help keep the door aligned in its frame. Otherwise it can warp over time. Regular use of the turn buttons keeps the door 'trained'. Please ensure that your door is securely fastened in windy conditions to prevent damage to the hinges or door posts.

Felt-

Your shedfast building comes with a good quality polyester backed felt which is harder to rip than regular shed felt. Keep an eye on your felt as a part of your ongoing maintenance and repair or replace it promptly if it deteriorates (for example after a storm) before water has chance to get in and damage the shed.

Base Sizes

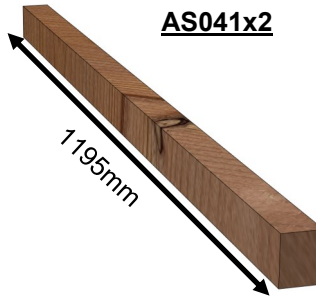
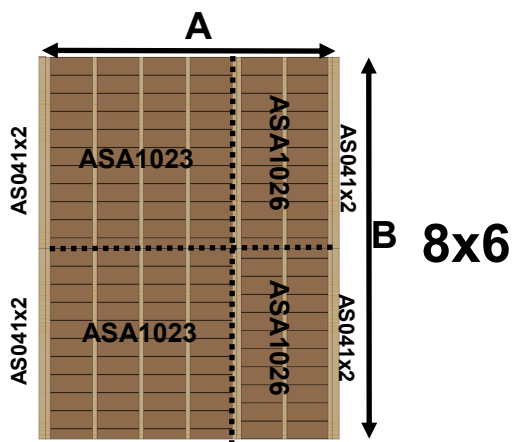

Panels	Size	Quantity
ASA1023	1195x1195	2
ASA1026	1195x600	2
AS041X2	44x56x1195	4

Length (A)	Width (B)
1878mm	2390mm

NOTE: The shed overhands the floor so adds approx. 30mm

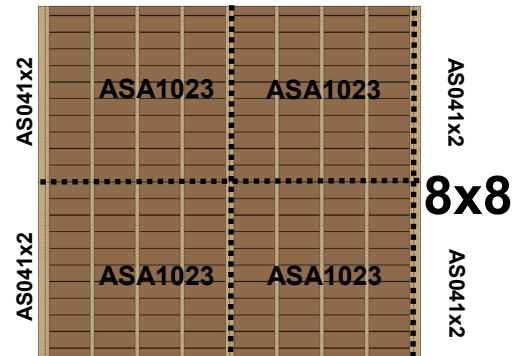

NOTE: All floors are shown from underneath

Panels	Size	Quantity
ASA1023	1195x1195	4
AS041X2	44x56x1195	4

Length (A)	Width (B)
2078mm	2390mm

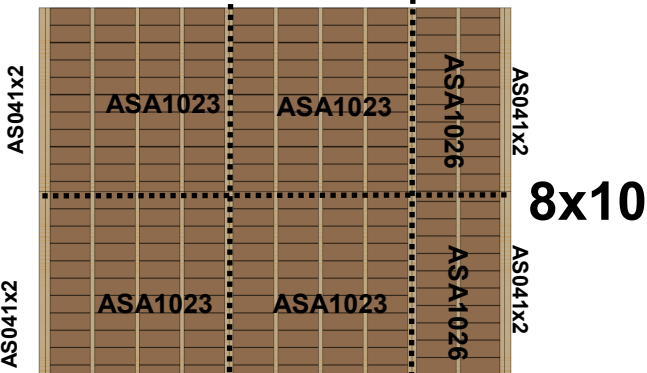

Panels	Size	Quantity
ASA1023	1195x1195	4
ASA1026	1195x600	2
AS041X2	44x56x1195	4

Length (A)	Width (B)
2478mm	2390mm

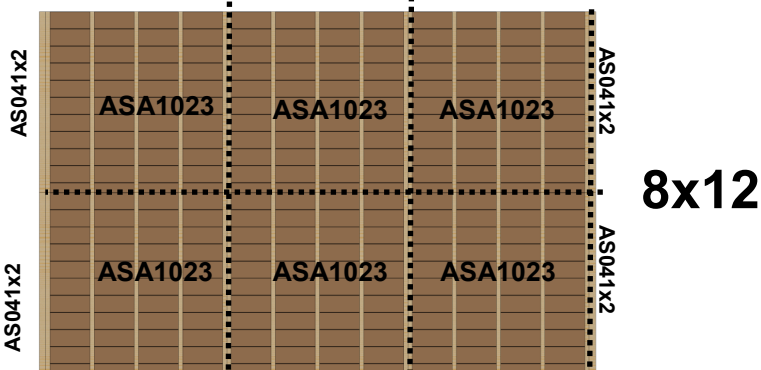

Panels	Size	Quantity
ASA1023	1195x1195	6
AS041X2	44x56x1195	4

Length (A)	Width (B)
3668mm	2390mm

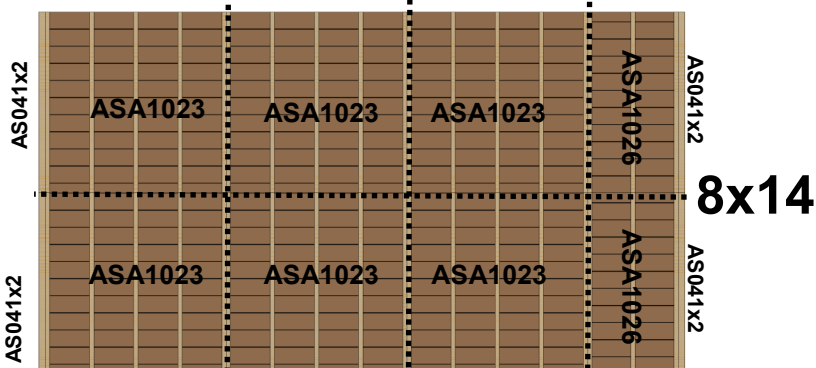

Panels	Size	Quantity
ASA1023	1195x1195	6
ASA1026	1195x600	2
AS041X2	44x56x1195	4

Length (A)	Width (B)
4224	2390mm

Shed Base System (Optional)

The base system is made up of sections that mirror the size of the floor panels . Finally, at each end you need to add an extra batten (AS106) to make the length up.

<u>SHED SIZE</u>	<u>AS103 (300mm)</u>	<u>AS104 (512mm)</u>	<u>AS105 (1107mm)</u>	<u>AS106 (1196mm)</u>	<u>AS107 (1490mm)</u>	<u>AS108 (1790mm)</u>	<u>80mm Screws</u>
<u>8x6</u>	9	6	6	12	0	0	110
<u>8x8</u>	9	0	12	12	0	0	110
<u>8x10</u>	12	6	12	16	0	0	156
<u>8x12</u>	12	0	18	16	0	0	156
<u>8x14</u>	15	6	18	8	0	0	202

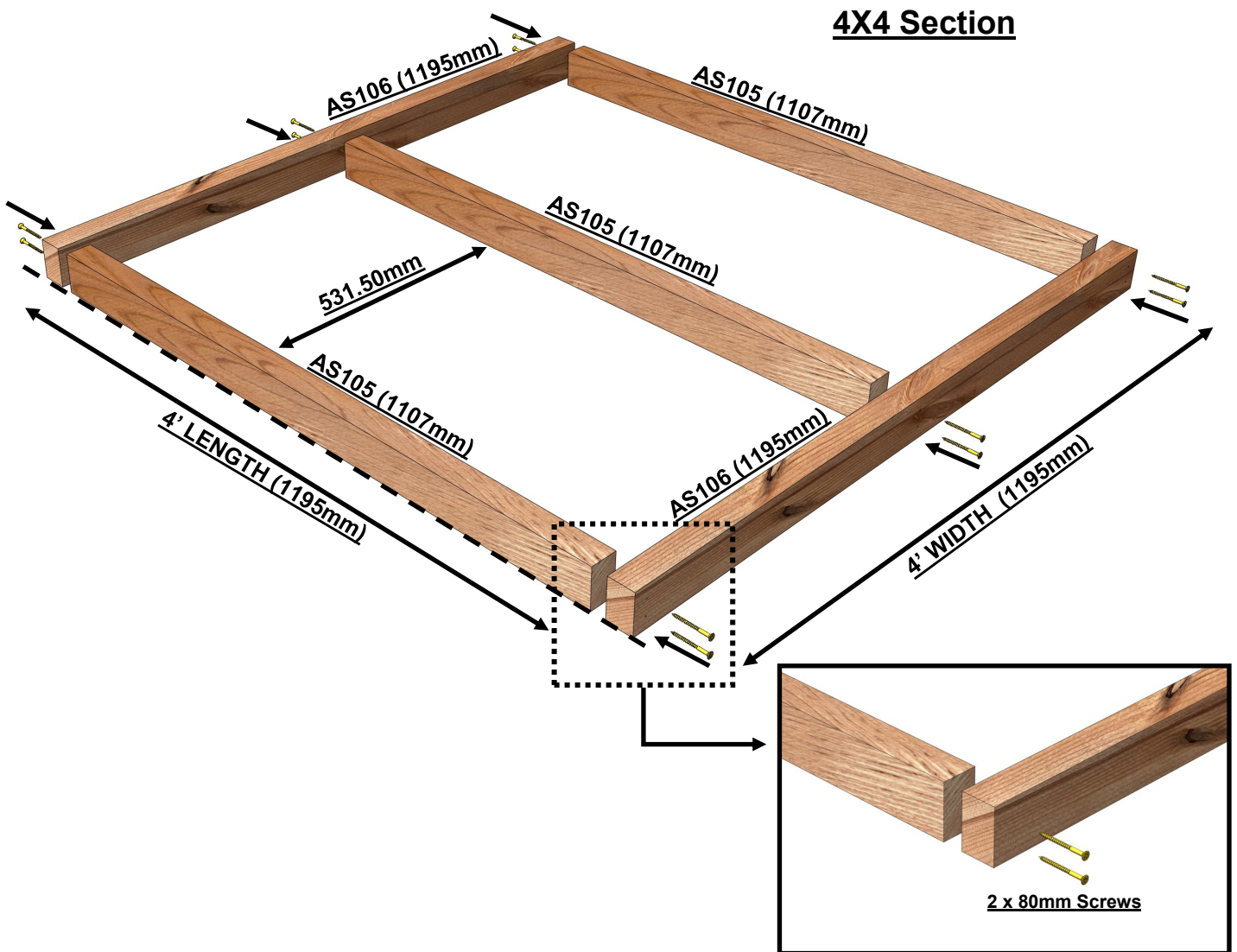

4x2 Section

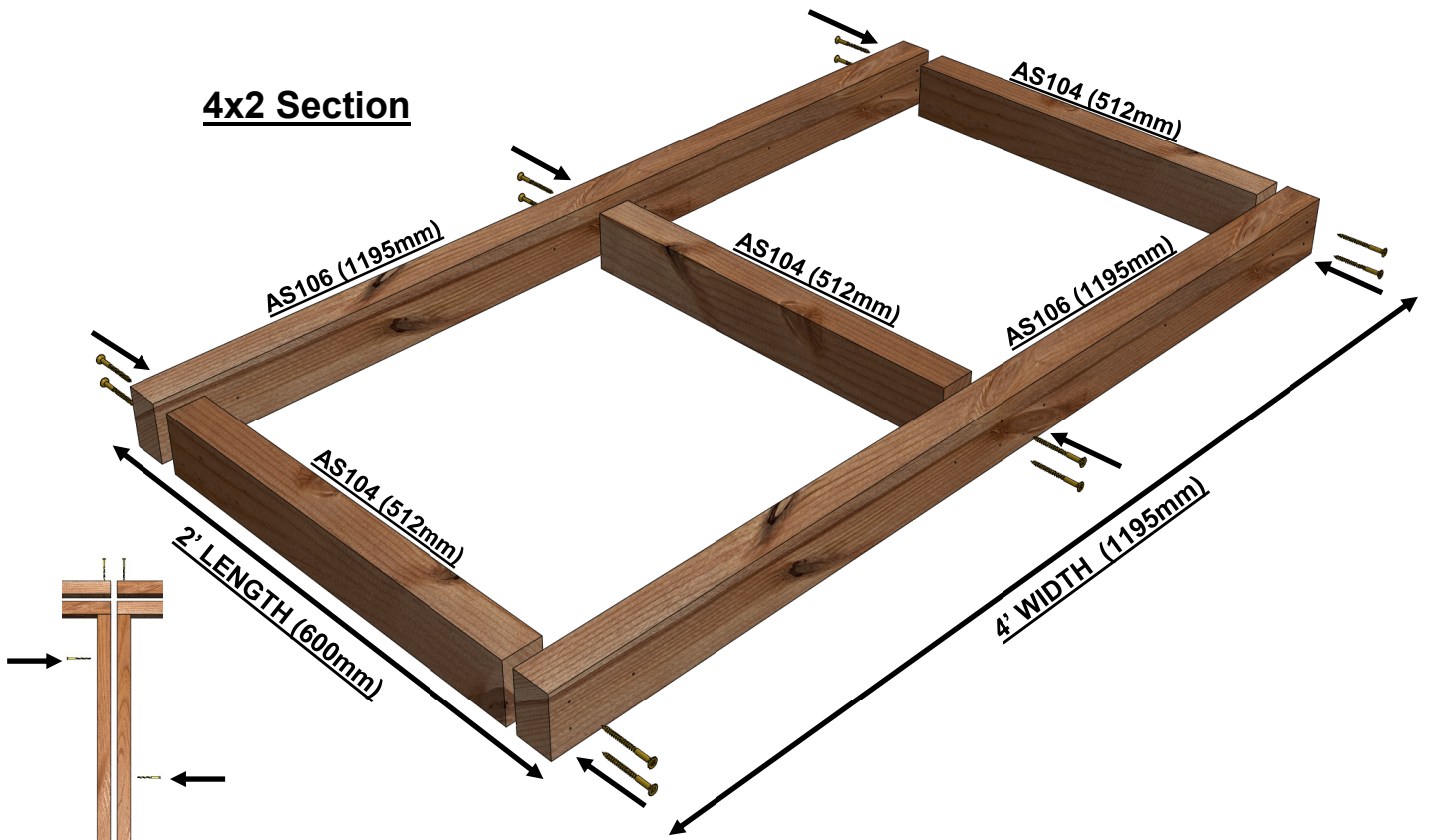

8x6 Example

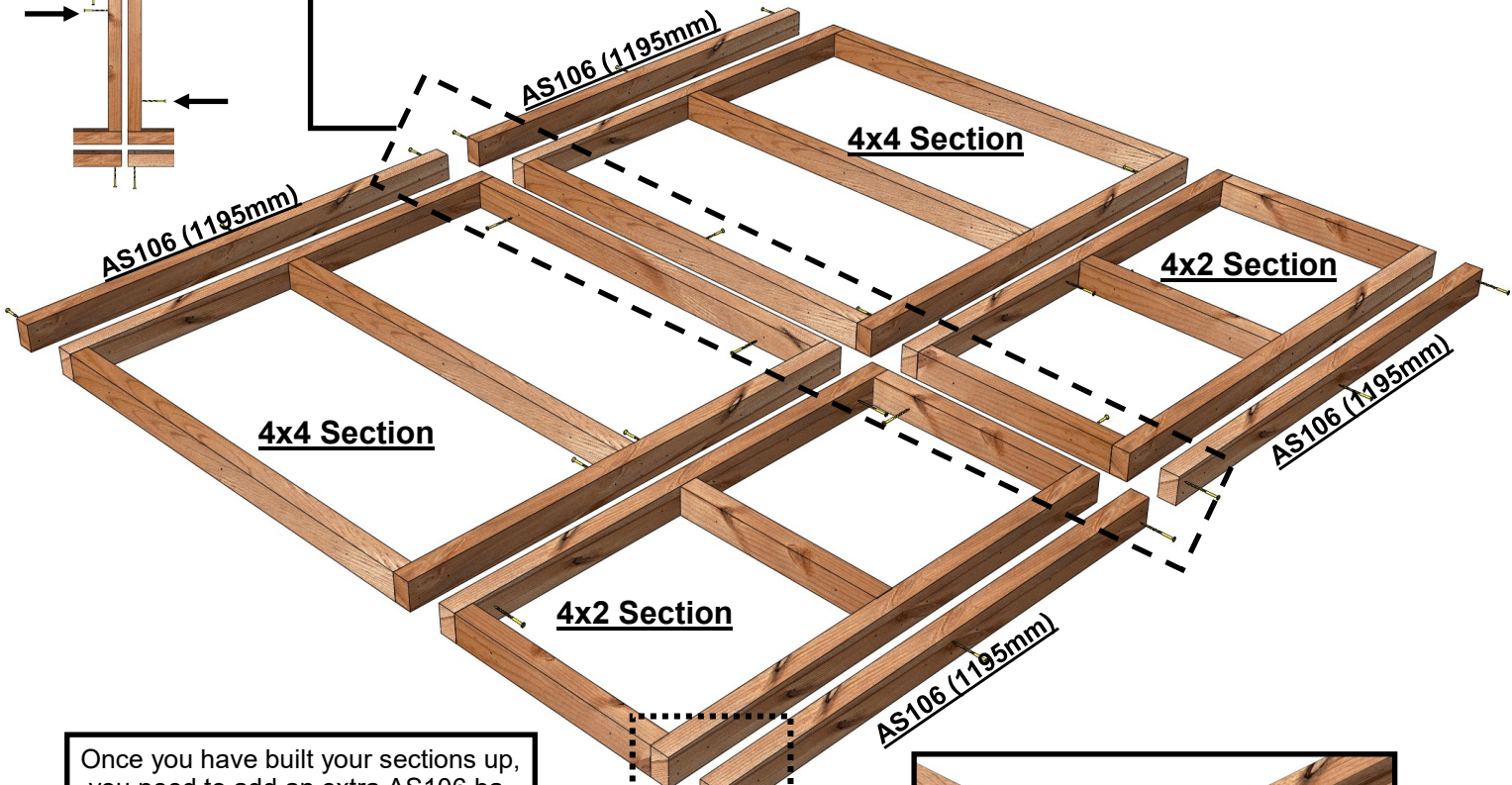

Once you have built your sections up, you need to add an extra AS106 baton on each end to make up the length. You need to screw the sections together using 80mm screws.

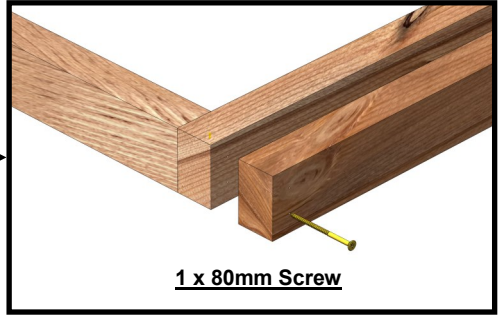

1 x 80mm Screw

8x8 Example

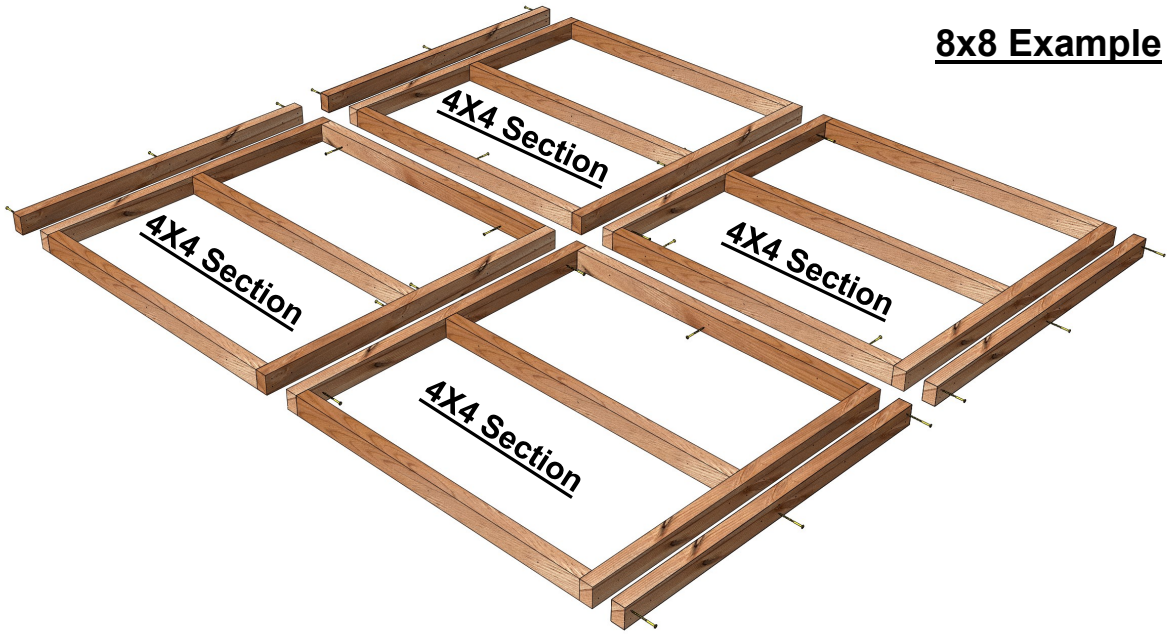

8x10 Example

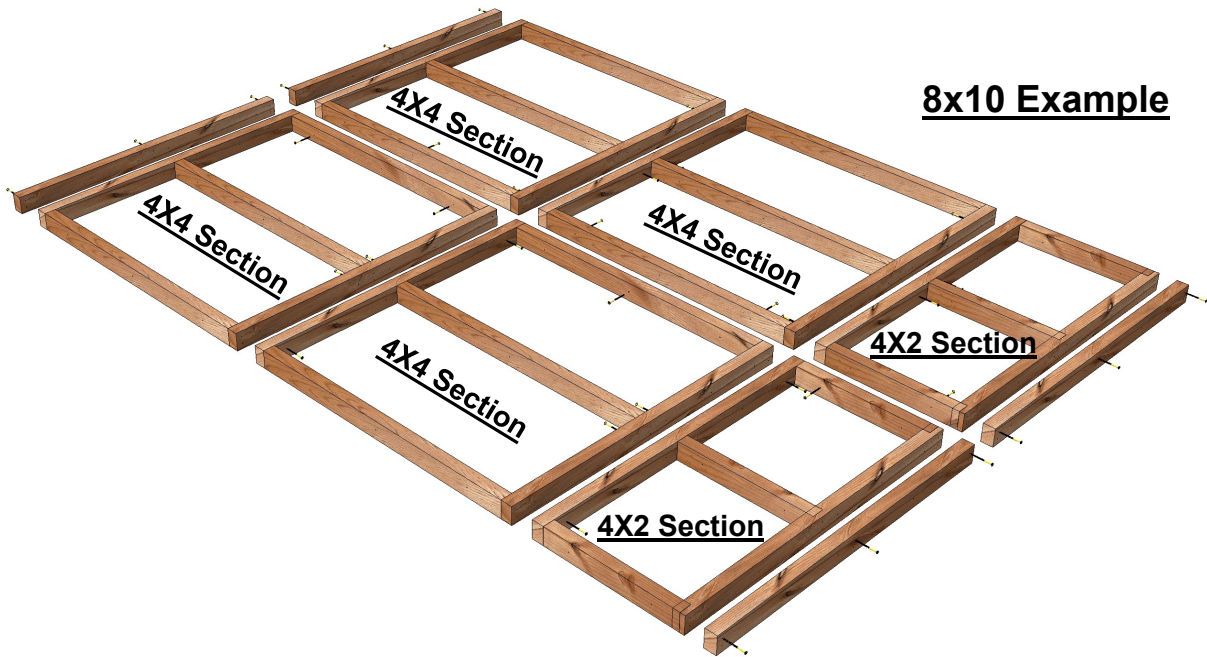

8x12 Example



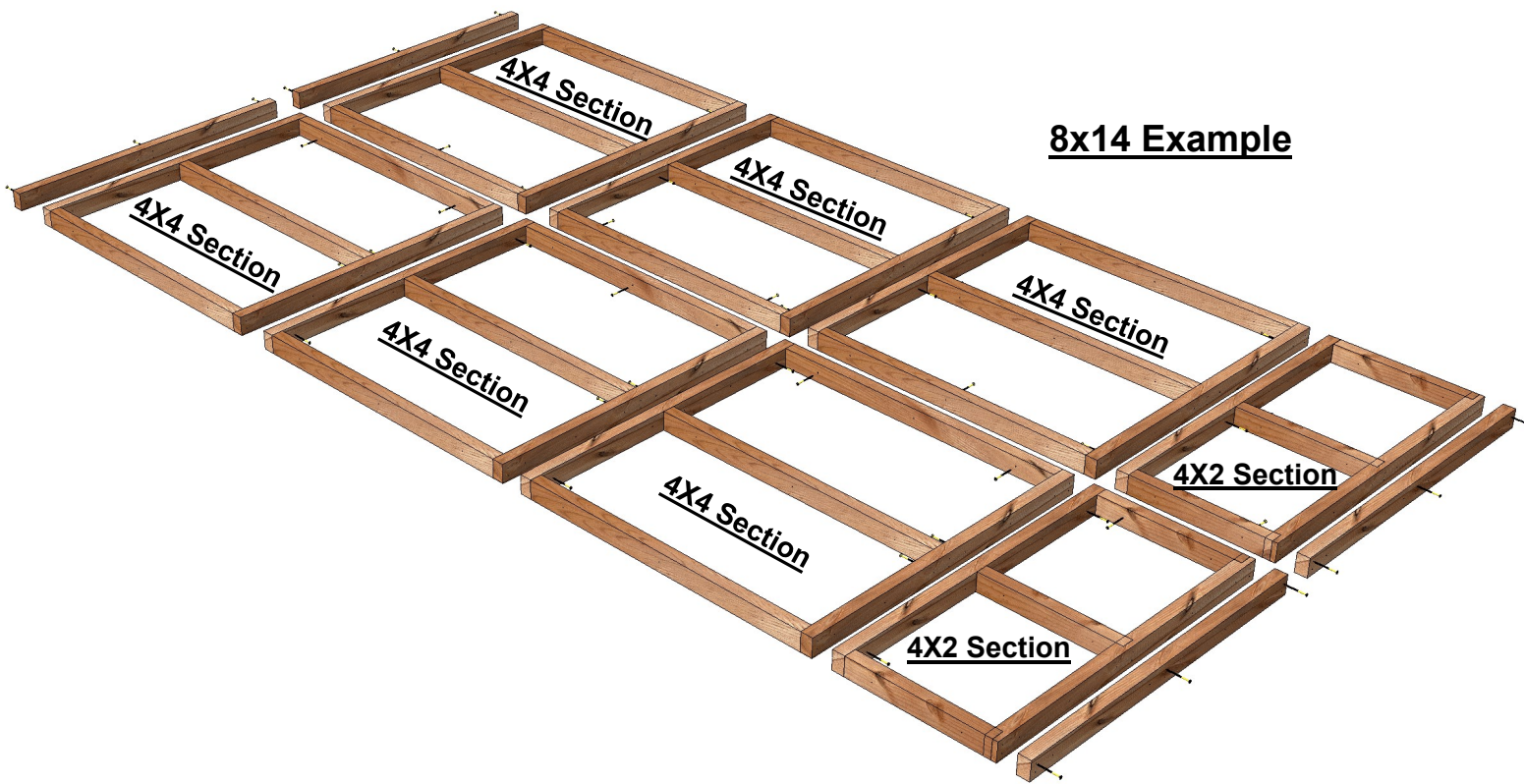

8x14 Example

You will received **AS103 (300mm)** legs with your base. These are to help you level your base before you put the floor on top. You can either put the legs on vertically if you have a big gap to level and saw off the top, let the legs sit into concrete holes in the base below or lie the legs horizontally if you only have a small gap to level. Use a spirit level to ensure the level of the base. You can spread these around the corners of the base to get the best level possible.

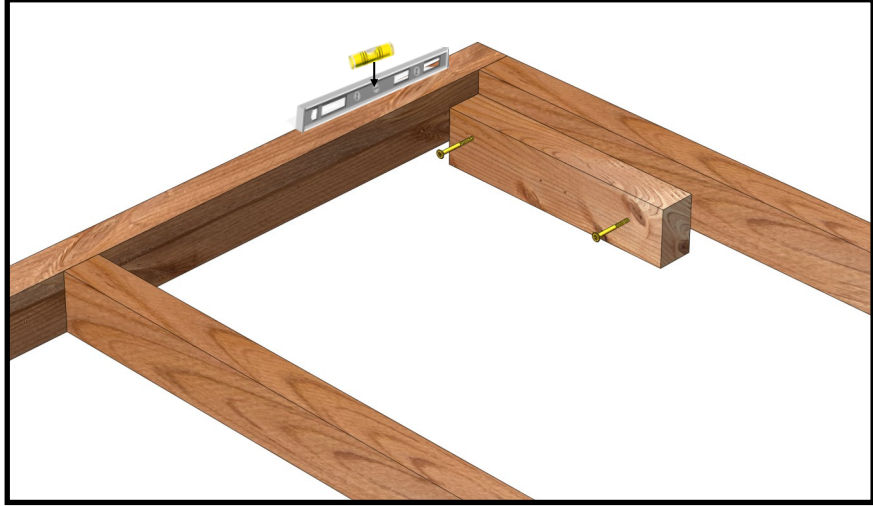
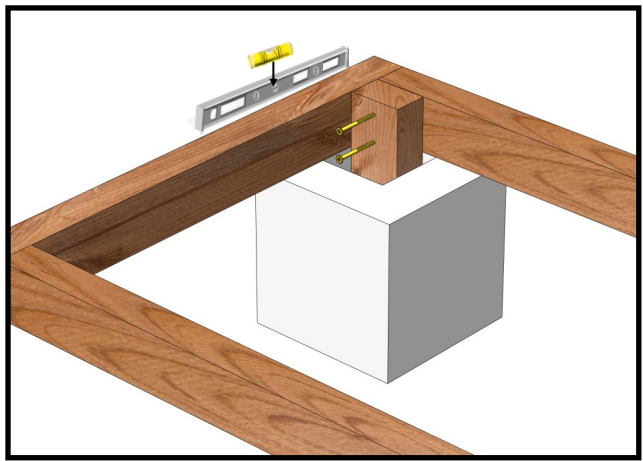
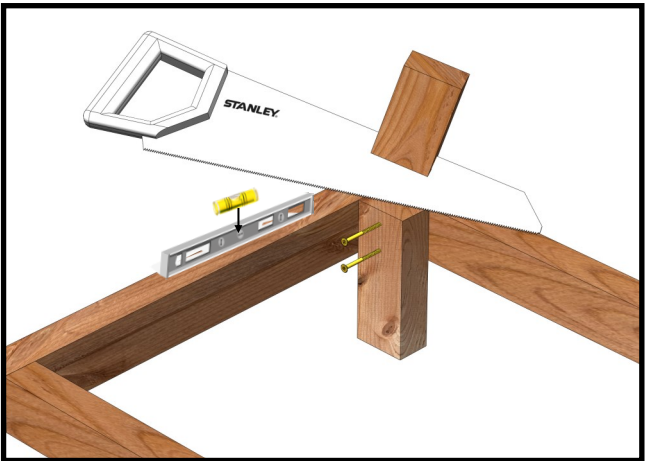

Panel Placement

Before you begin your build you need to decide where you would like your door and window panels. Because the panels are the same width, they are interchangeable. This means you can put the door, window and plain panels basically wherever you want. See below for an example of the 8x10 and 8x12 with the door in the gables and the door on the sides. The gable door can go towards the left or the right and when the door is in the sides it can go in either position, left or right

NOTE: The door is ambidextrous, so simply turn it upside down to change the hinge side to have it opening whichever way you want.

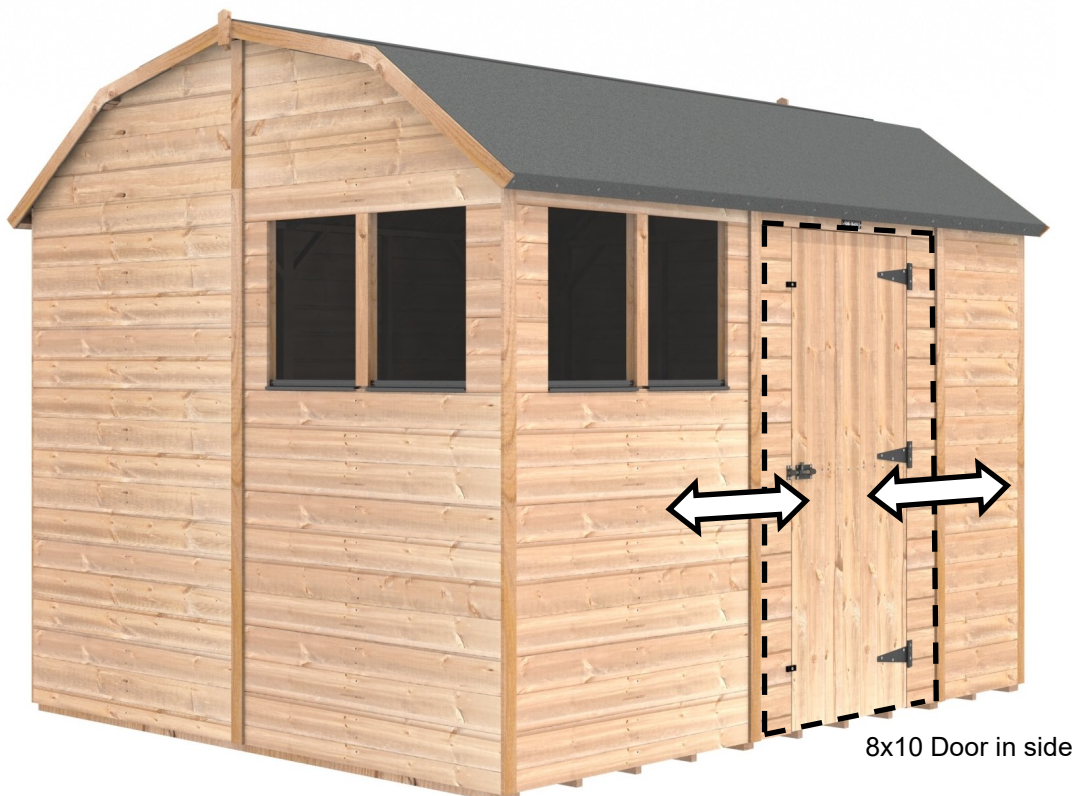

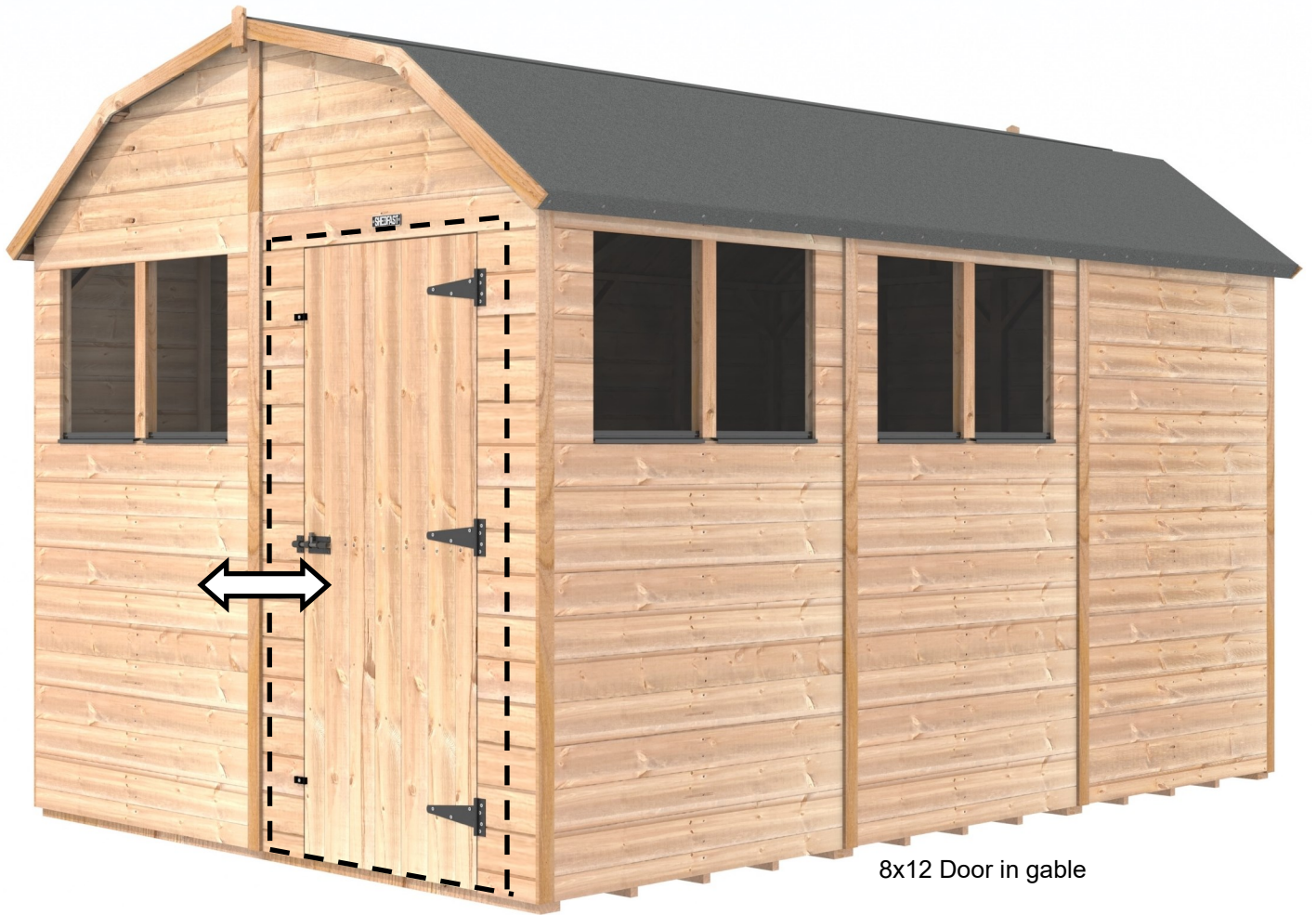

8x12 Door in gable

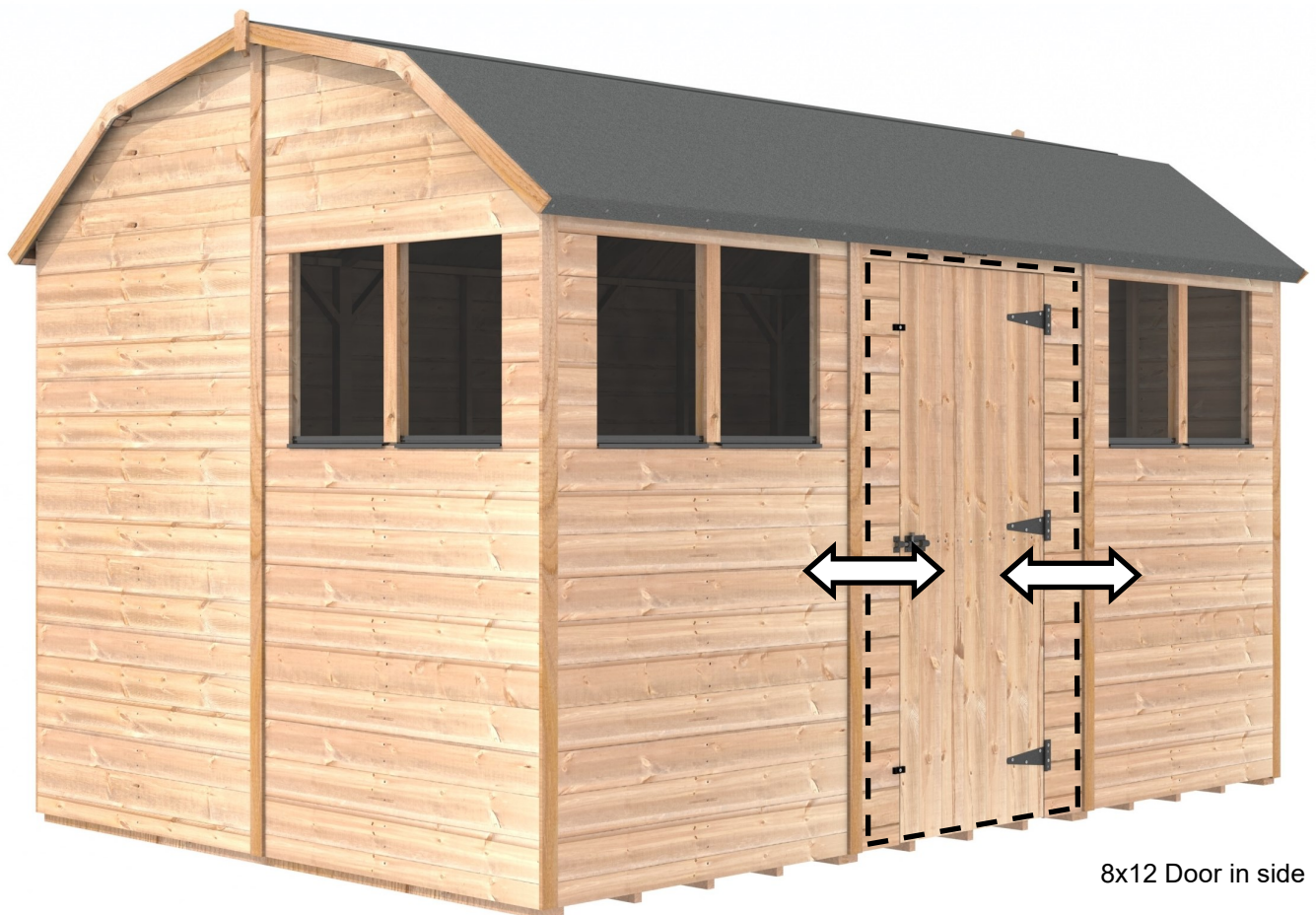

8x12 Door in side

Floor Assembly

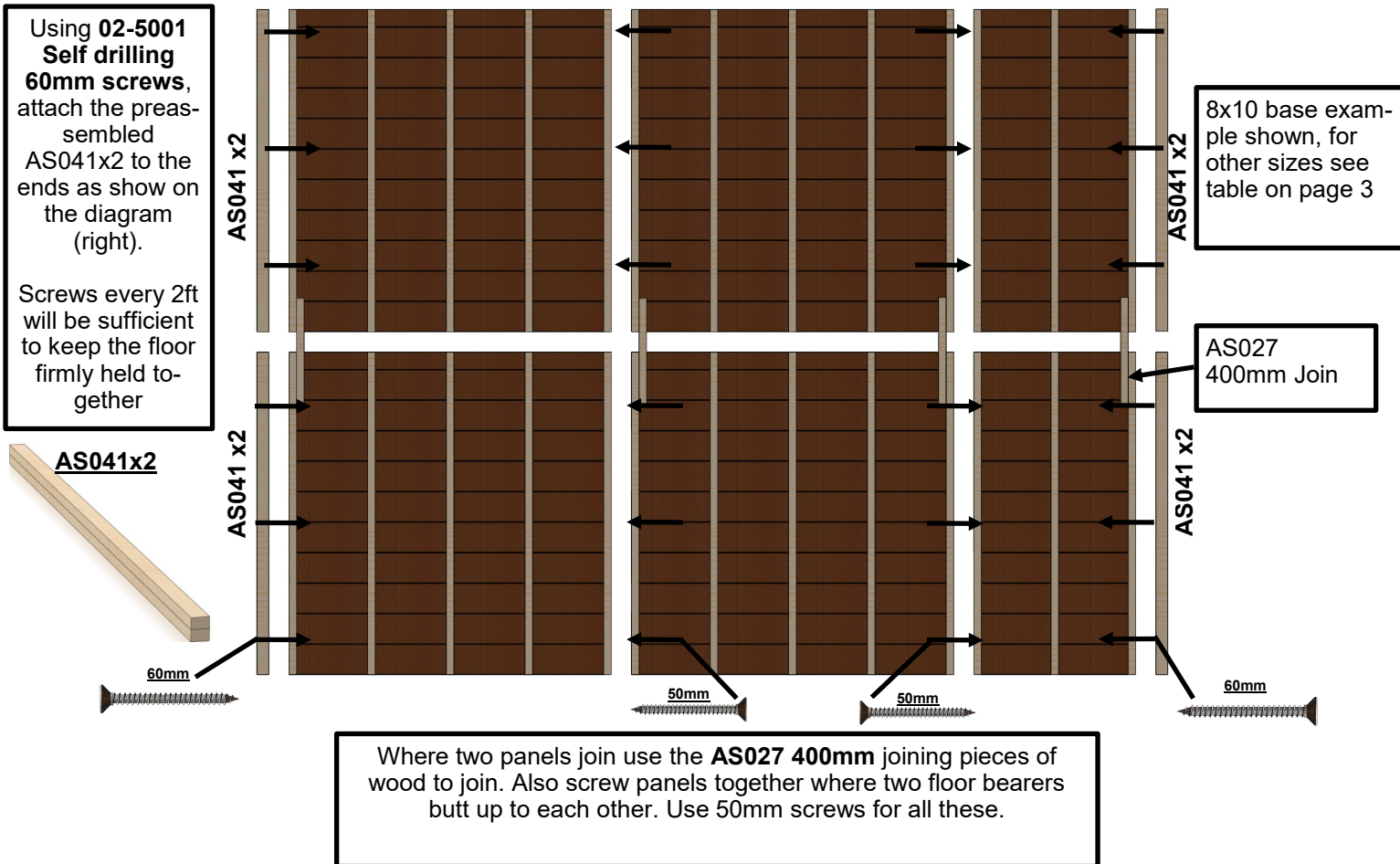

Laying the floor onto the base

Once you have assembled the floor you need to now lay this onto the base. Ensure the base is flat and level by using a spirit level. Then lay the assembled floor onto the base, once again checking that everything is flat and level.

A flat and level base is vital because if it is not level then you will experience problems such as the door not opening or closing properly, the roof not fitting properly and you may get gaps appearing. Use the spirit level across the width and length of the floor.

NOTE: Flipping the floor over and laying it onto the base should be done very carefully to avoid damage to the floor.

If you're building a floor that's 12ft or longer then you will have to screw the floors together when they're the right way or because it will be too big to flip. Use **50mm Screws and pilot drill** and screw from the top where the floors join and angle them so the screw goes through into both floors.

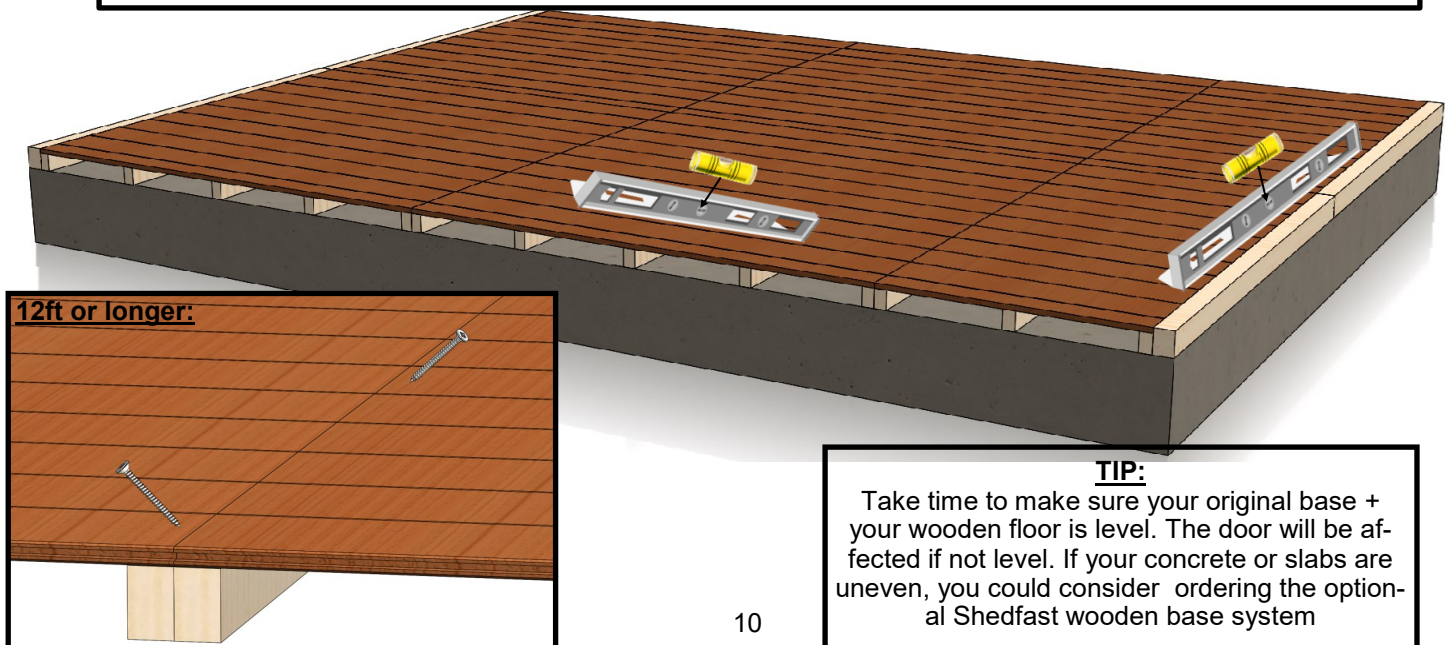

Door Panel Assembly

PLEASE SKIP TO NEXT PAGE FOR THE JUMBO DOUBLE DOOR OPTION

You can position the door panel more or less anywhere on the shed when assembling. At this stage you need to decide whether to hinge the door on the left or right. The door is ambidextrous, so simply turn it up-side down to change the hinge side.

Fit the door in the door panel by lying down, evening up the space and screwing hinges on using **35mm screws 02-1814**

Add toggle buttons and pad bolt using **35mm screws 02-1814**

Add the name plate using **13mm screws**



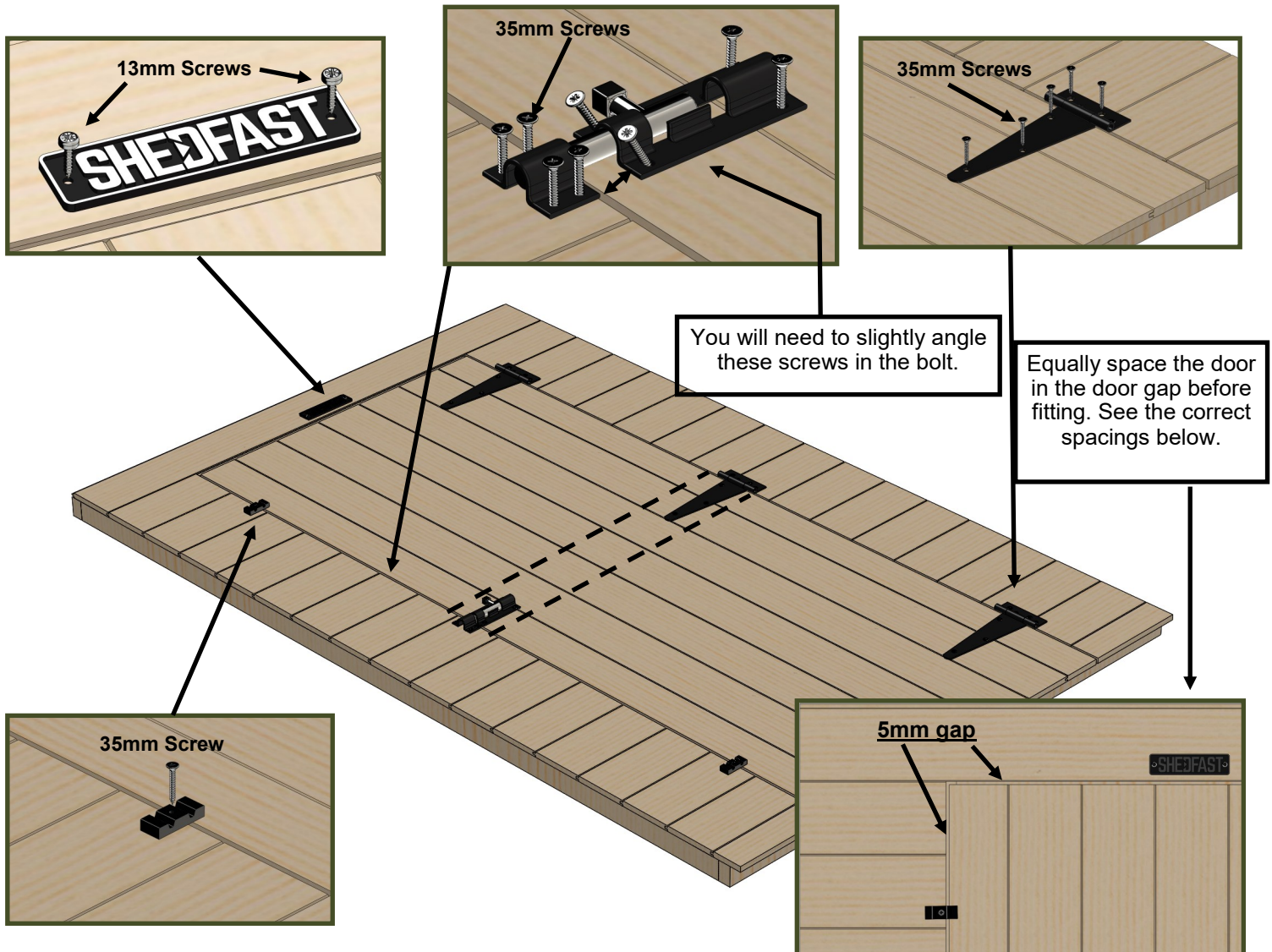



When screwing the lock on, make sure you line it up with the brace on the inside of the door (see dotted line below)

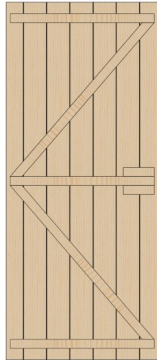

<u>Part Code</u>	<u>Quantity</u>
ASA1005 Single Door Panel 1200x1856	1
ASA1008 Single Door 740x1751	1
AS302 Hinges (already on the door)	3
AS303 Pad Bolt	1
AS304 Turn Button	2
AS306 'SHEDFAST' Name Plate	1

Double Door (Optional)

If you have the double door option for your shed, please follow the below instructions. If not, please skip to page 16 as this wont apply to you.

	<u>ASA1074 1.5ft RH Panel 486x1881mm</u>	<u>ASA1075 1.5ft LH Panel 486x1881mm</u>	<u>ASA1076 Door Header Panel 1476x140mm</u>	<u>ASA1008 Single Door 740x1751mm</u>	<u>AS303 Pad Bolt</u>	<u>AS127 Framing 44x44 1670mm</u>	<u>AS128 Framing 44x28 1467mm</u>
							
<u>QTY</u>	1	1	1	1	2	1	1

Removing the transit blocks

Before you start putting the sides onto the floor, you need to remove the transit blocks. They are nailed on to protect the overlapping cladding from snapping while in transit. Remove these blocks carefully using a hammer.

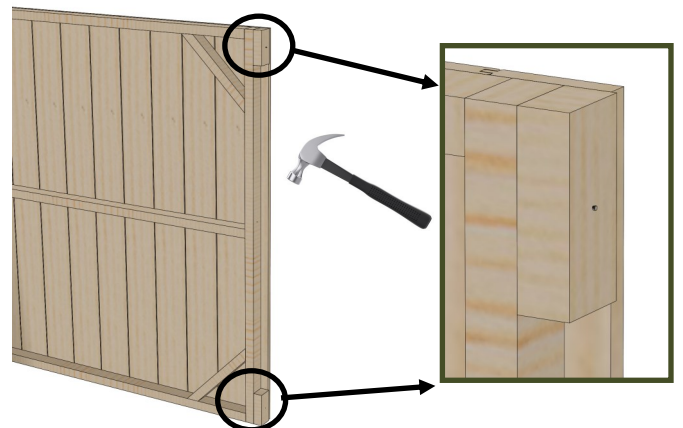

The double door option will spread over 8ft. You will get 1x ASA1074, 1x ASA1075 and 1x ASA1076 which attach together using **50mm wood screws**.

When attaching the sides together, use three **50mm wood screws** per vertical and ensure you make pilot holes with a 4mm drill bit.

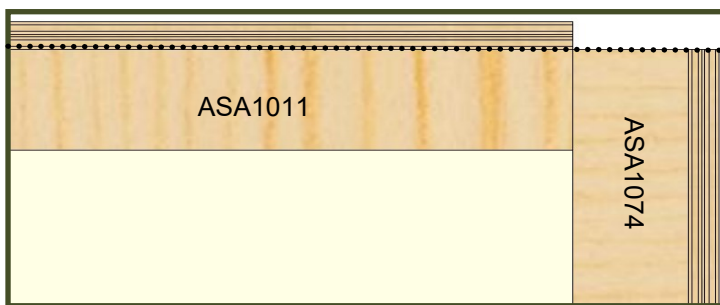
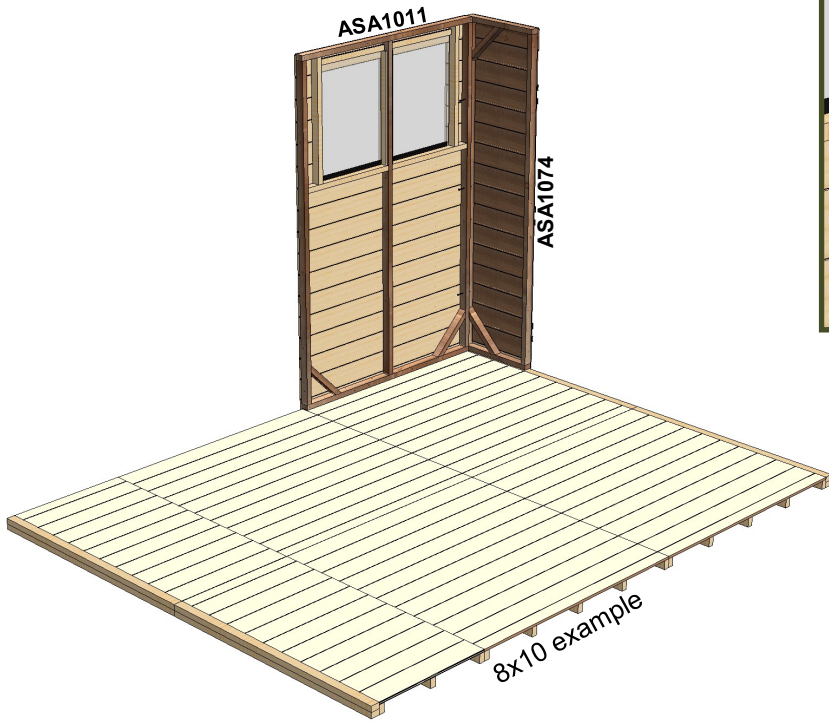

See how when the panels are lined up correctly, the cladding sits proud.

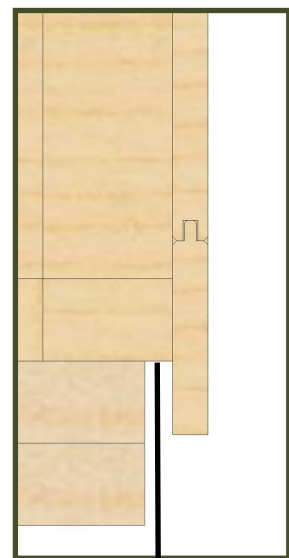

Allow for an approx. 5mm overhang between the floor and the side panel.



Repeat the previous steps on the opposite side so that you have a gap in between ready for the ASA1076 Above door panel.

You're now ready to put ASA1076 Above door panel in. Secure it to the ASA1074/75 1.5 panel with an **80mm screw**. Make sure it is flush with the top so the gable ASA1065/64 can sit properly on top.

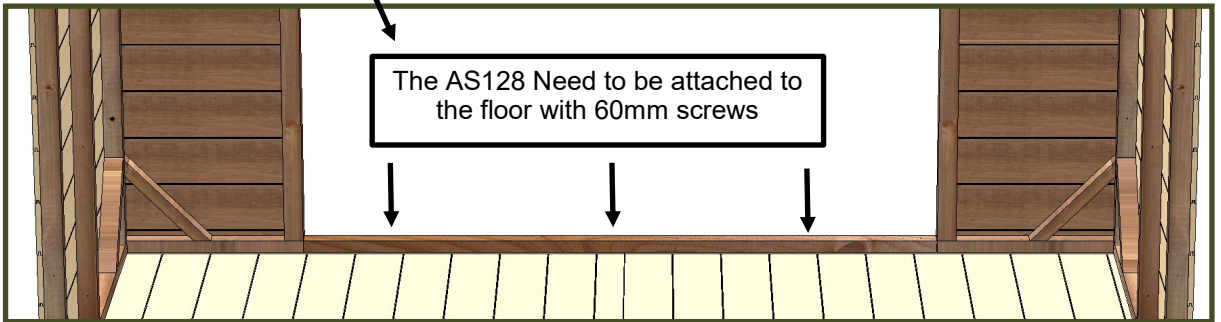
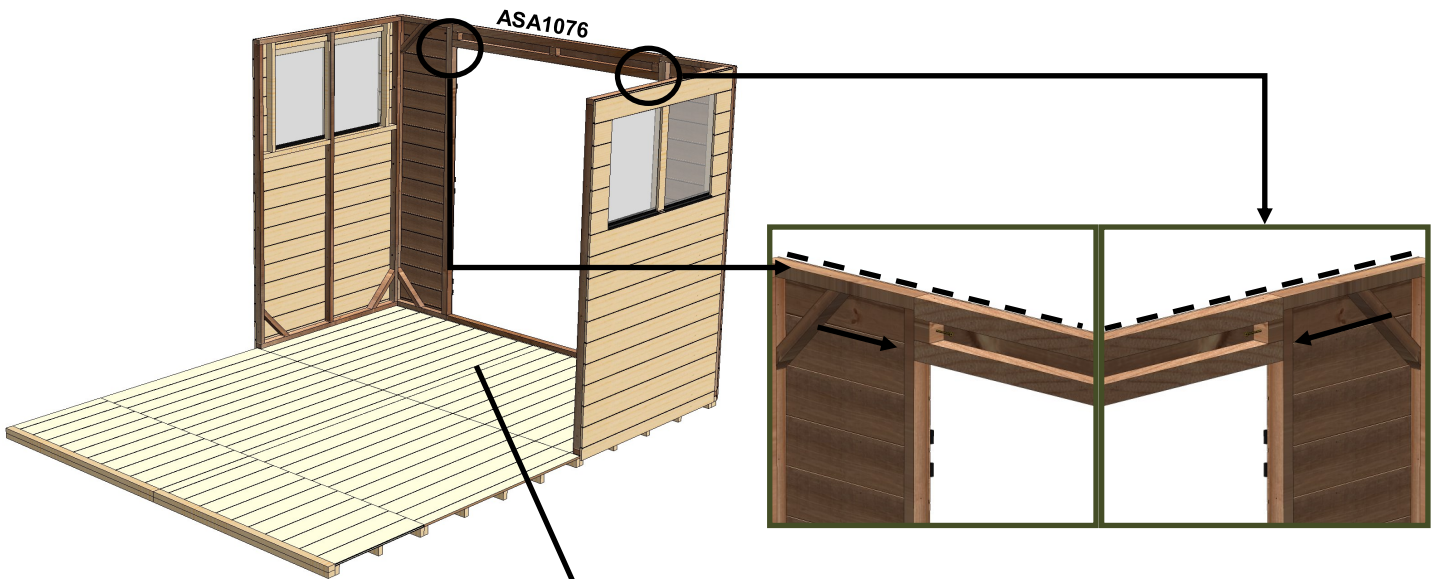

Refer to page 11 on how to install the doors into the door panels. With the double door option, you have to install the doors once the double door panel is actually fitted.

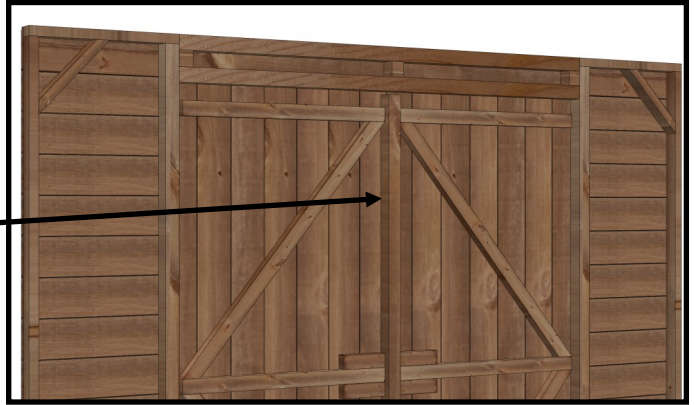

You now need to screw on the AS127 44x44 to the master door using 50mm screws.

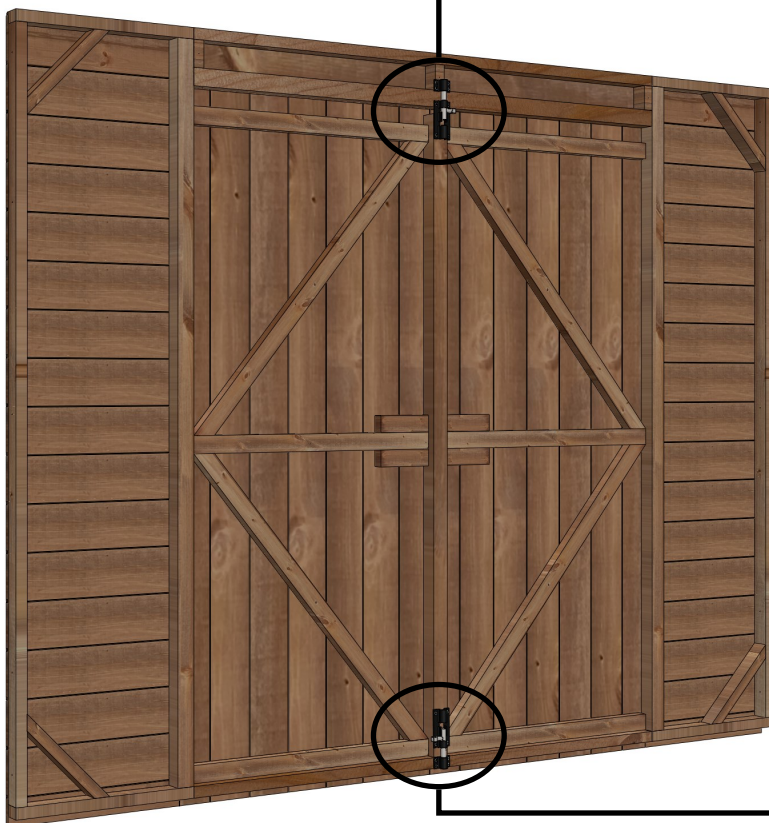
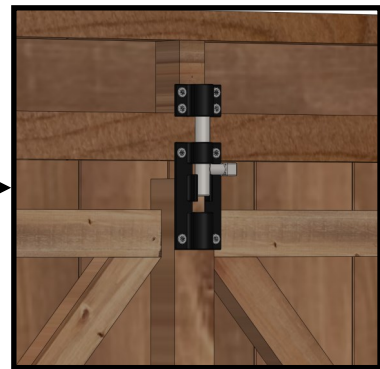

You will receive 2 x Pad bolts, these can be secured to the top and bottom of the AS127 that you screwed to the master door. This means that you can keep that locked. Use 35mm screws to secure these in place.

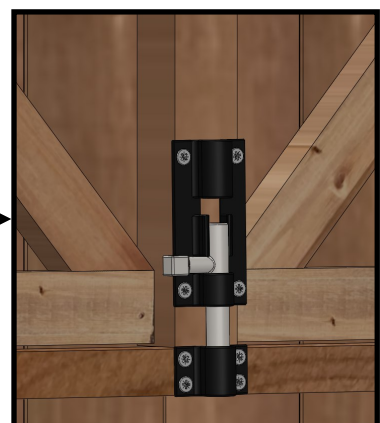

Sides Assembly

Removing the transit blocks

Before you start putting the sides onto the floor, you need to remove the transit blocks. They are nailed on to protect the overlapping cladding from snapping while in transit. Remove these blocks carefully using a hammer.

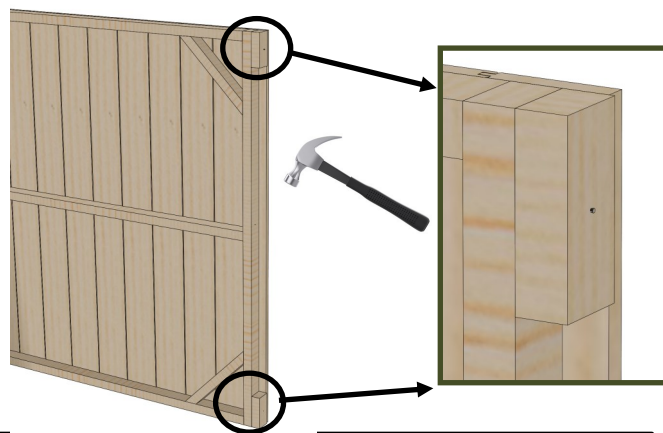

When attaching the sides together, use three **50mm wood screws** per vertical and ensure you make pilot holes with a 4mm drill bit.

NOTE: Because the plain, door and window panels are all the same size, you can position them wherever you want. There is no set order for them to be in, it's totally your preference. See exploded diagram on front cover.

OPTIONAL: You may want to fill any gaps around the corners of the windows with transparent all-weather silicone (not supplied) to prevent any water from leaking in.

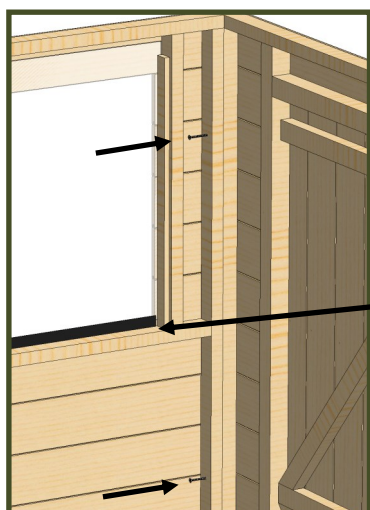

4mm

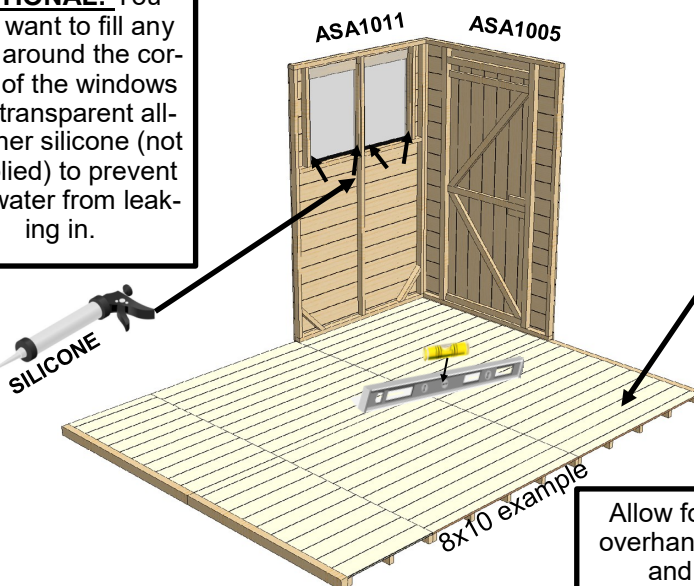

Allow for an approx. 5mm overhang between the floor and the side panel.

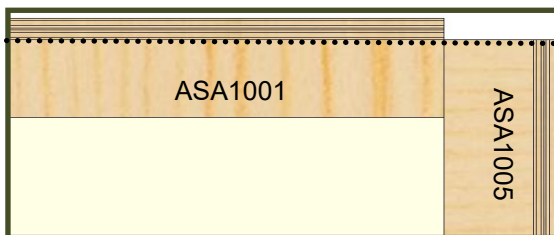
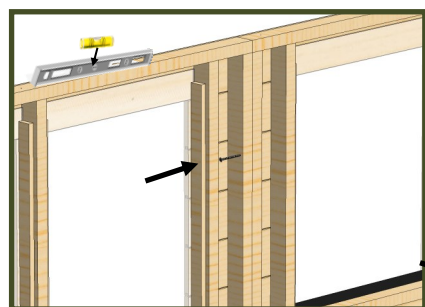

See how when the panels are lined up correctly, the cladding sits proud.

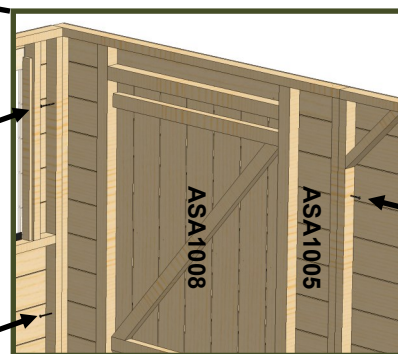
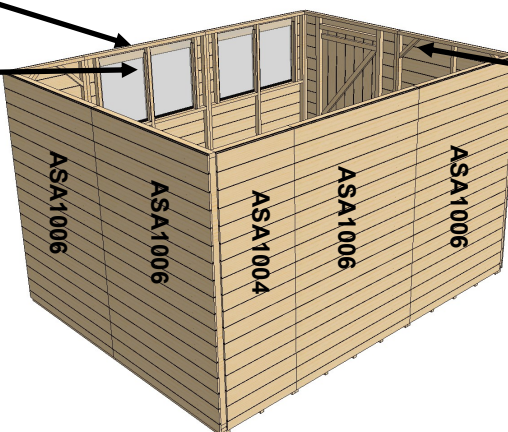
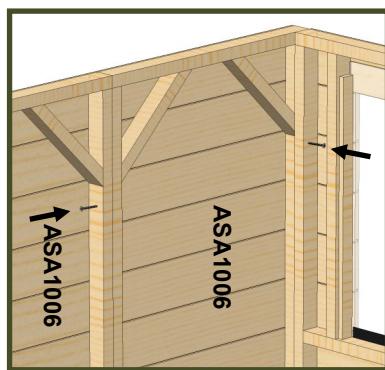

Trusses

Its very important to get the trusses spaced 22mm either side of the panel joins. This is because of the central baton of the roof panel. If the truss is in the correct place the roof panel will drop and fit nicely around the truss. Use 60mm self drilling screws to screw the trusses down.

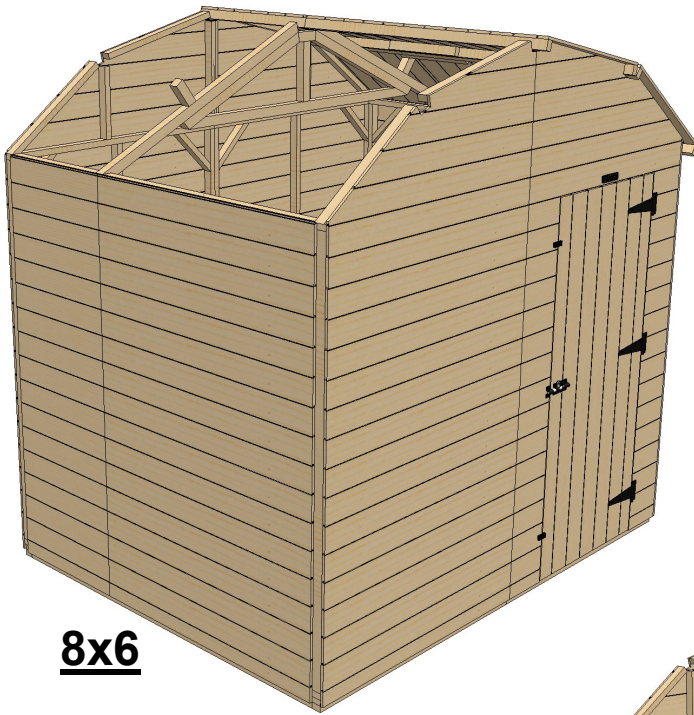

8x6

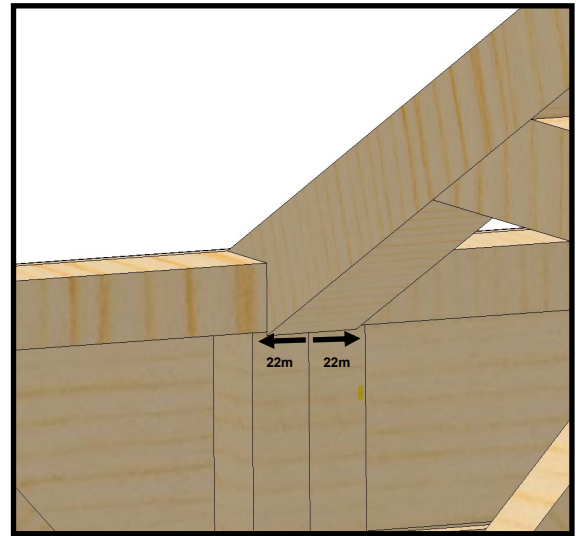

NOTE: On a 8x10 model, the trusses and roof panels must be as above, even if the ride panels are in a different orientation. It is not important that the side panel joint meets a truss but the joints in the roof must be over a truss.

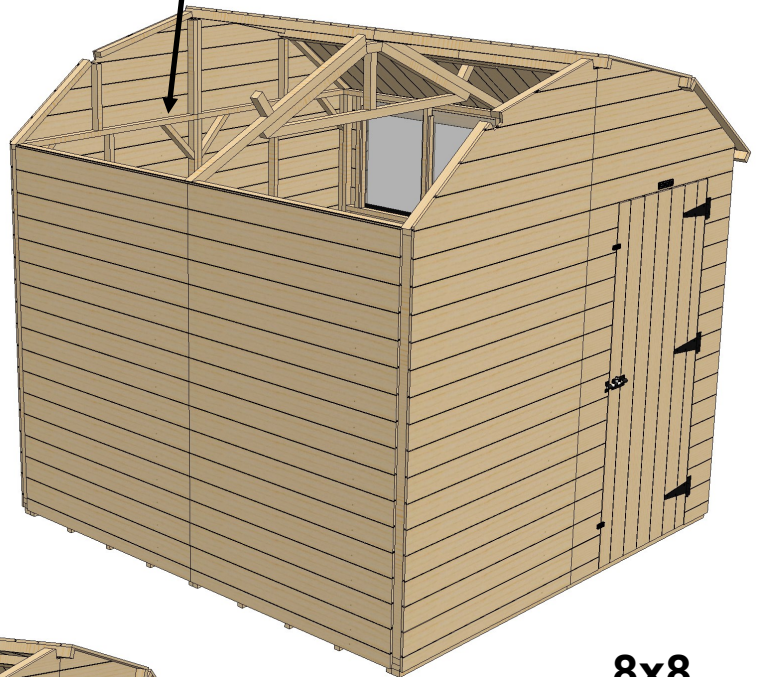

8x8



8x10

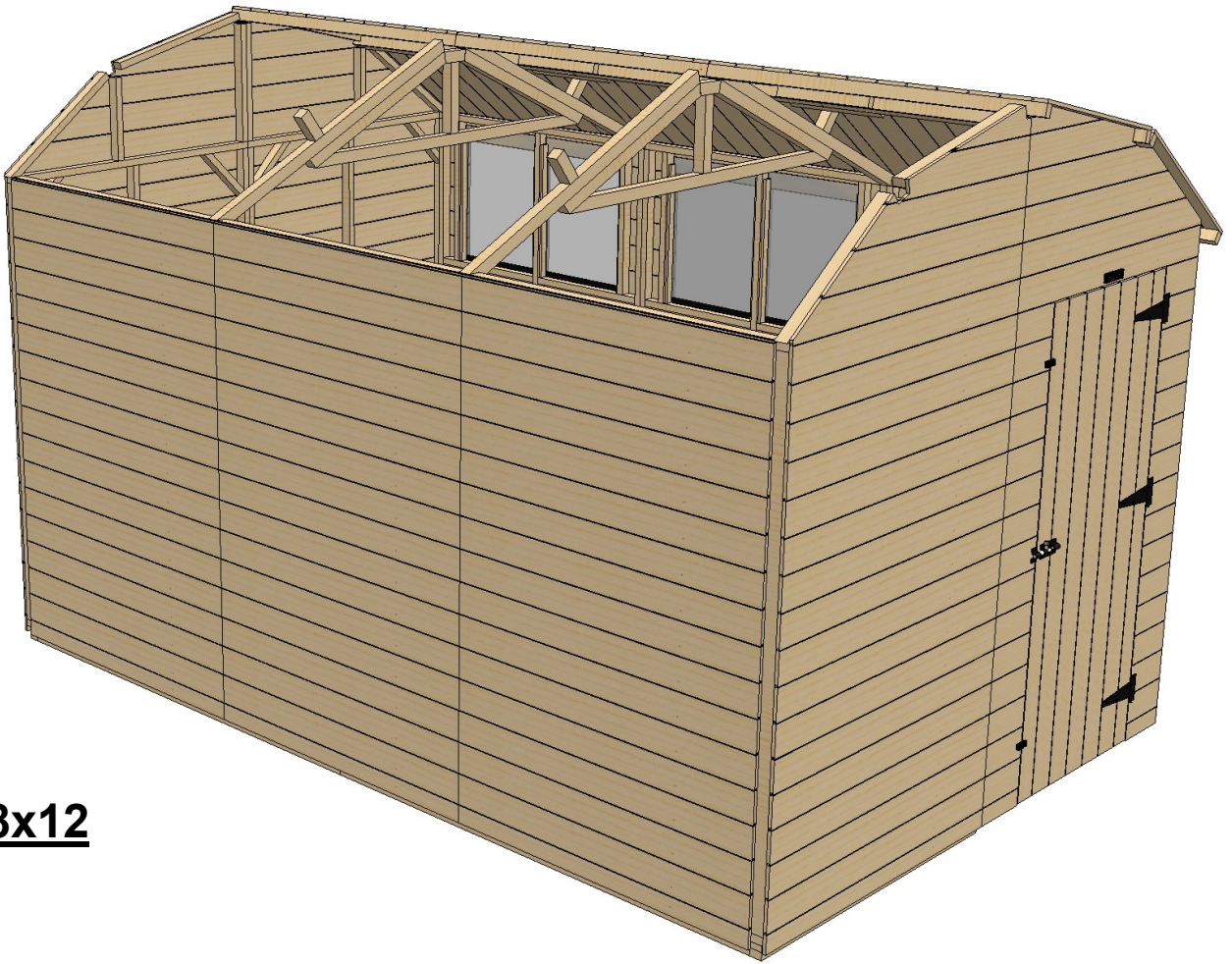

8x12

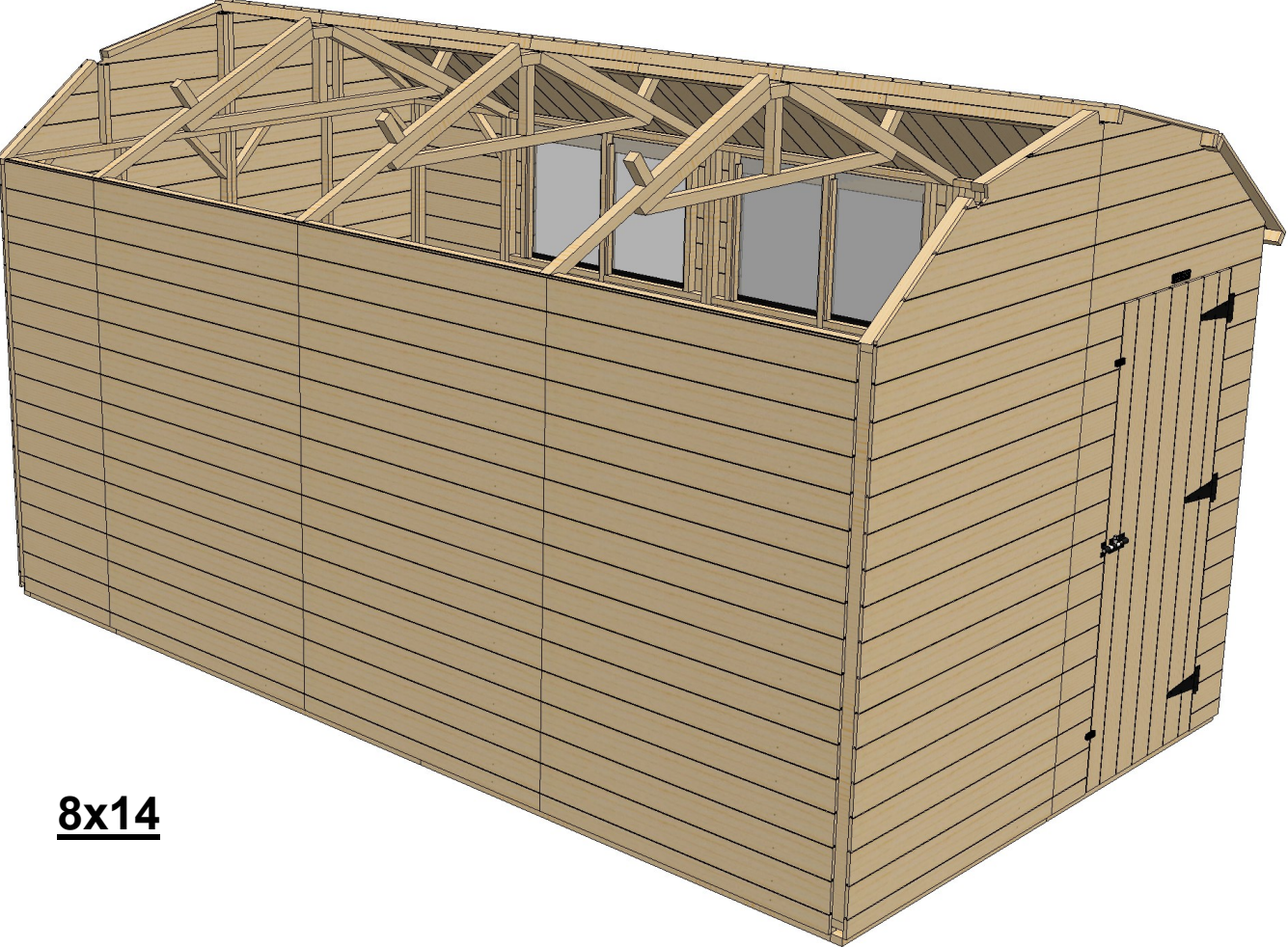

8x14

Assembling the apex pieces

You now need to assemble the apex pieces as they come in two parts, **ASA1064 8ft Barn Right** and **ASA1065 8ft Barn Left**.

Lay them out on the floor and **pilot drill 2 x 4mm holes** into the baton as seen below. Once you have made these pilot holes you can screw these together using **2 x 50mm screws**. Ensure the bottom of the apex panels are flush with each other before you attach them together so that when you put them onto the shed they sit correctly.

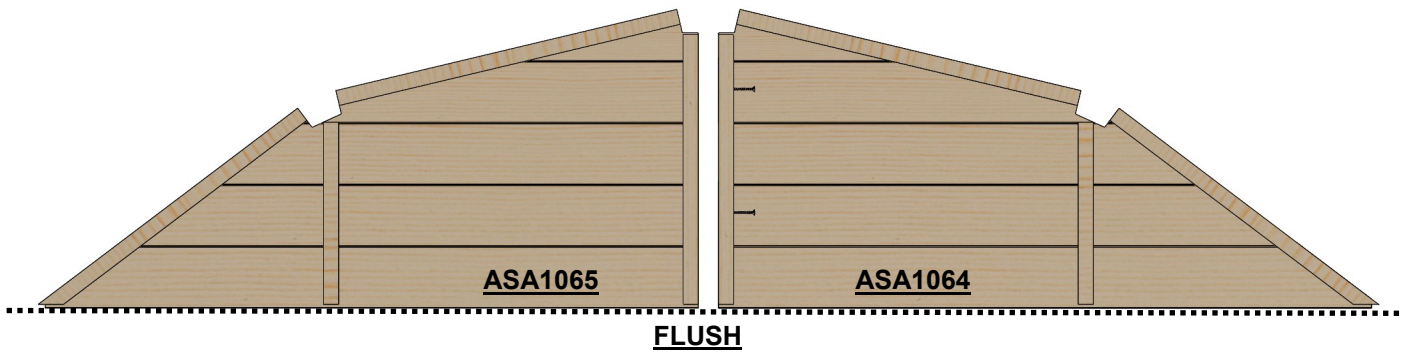
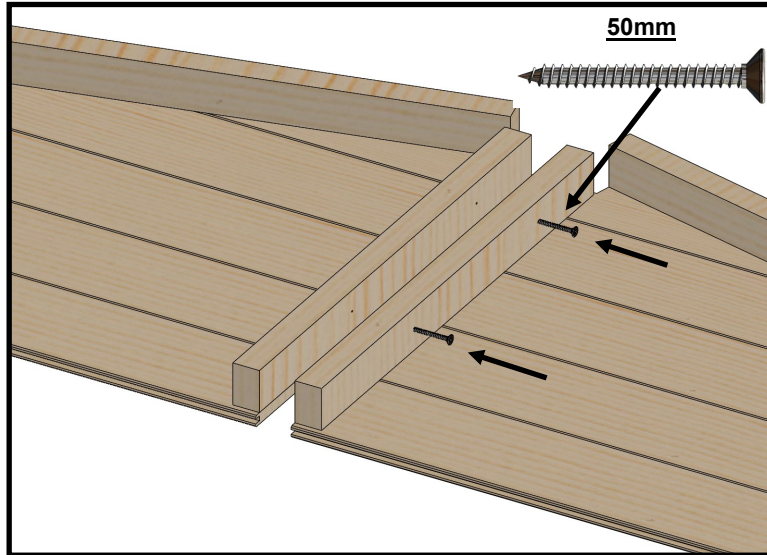

Truss Assembly

Its now time to assemble the truss. It will arrive in sections that you need to put together with **80mm screws**. You need to attach the separate **ASA1071** Assembly to the pre assembled truss frame **ASA1067**. See below for where to screw. Make sure that the **ASA1071** baton is nice and flush with the corner at the top

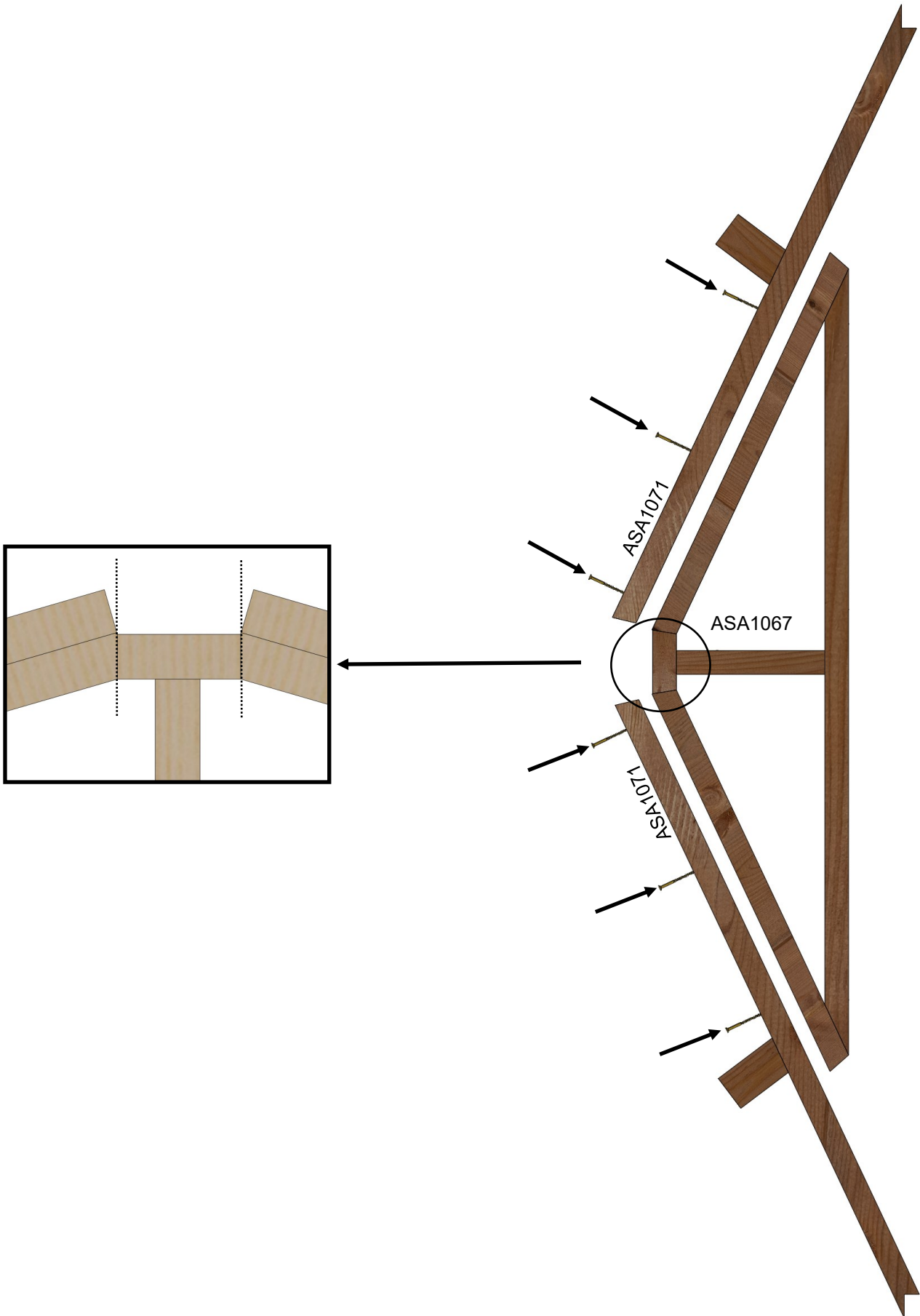

With each truss, you will receive **2 x AS203 Plywood** sheets which covers one side. These can be fitted with **35mm screws** by screwing through the plywood into the **ASA1067 Frame**..

Refer to the 3 circles below to see where to line up the plyboard with the truss frame.

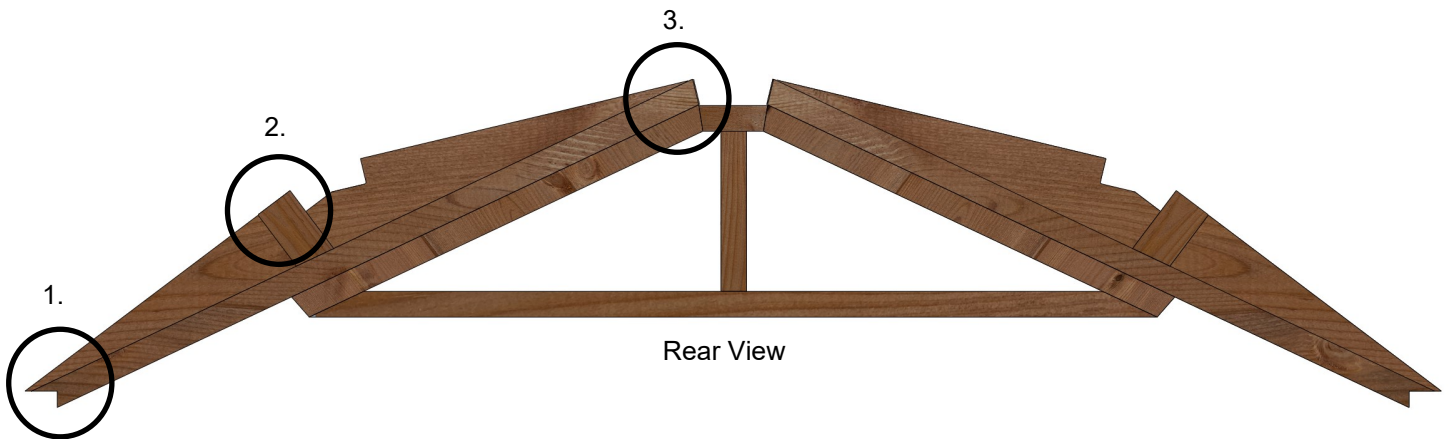

The dotted line is the outline of the plyboard.

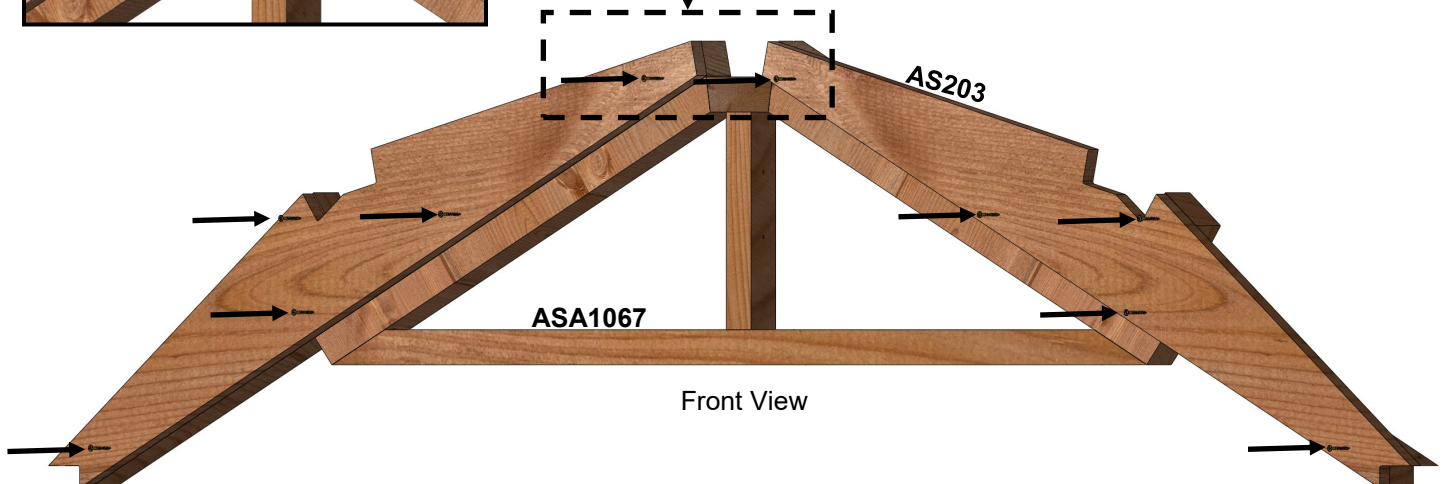
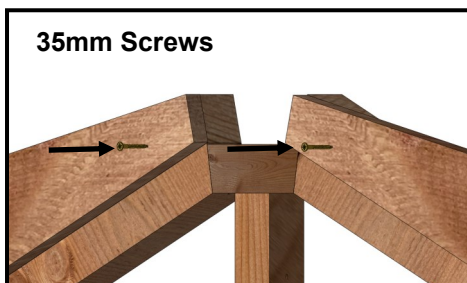
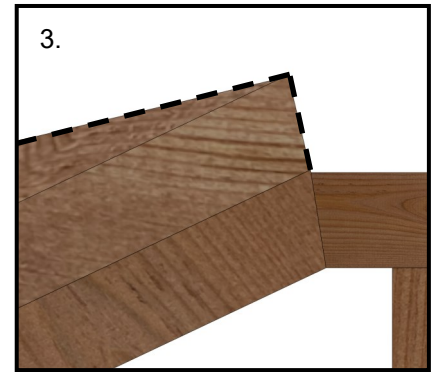
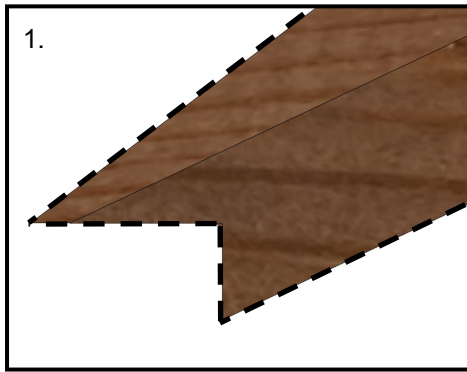

Roof Assembly

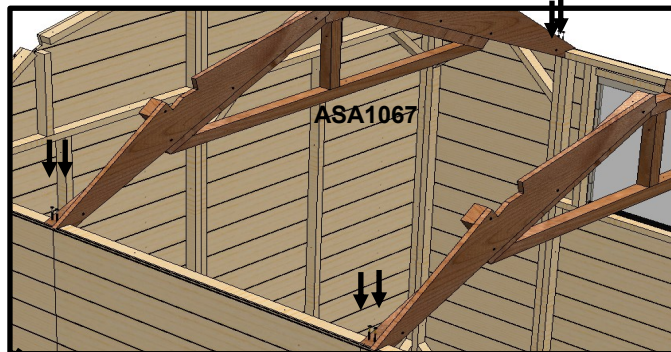
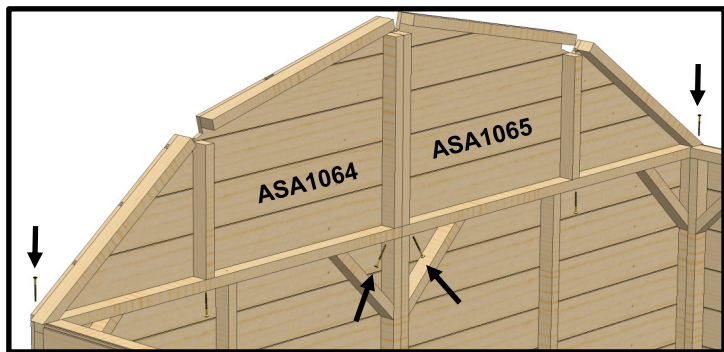

60mm Self Drilling screws

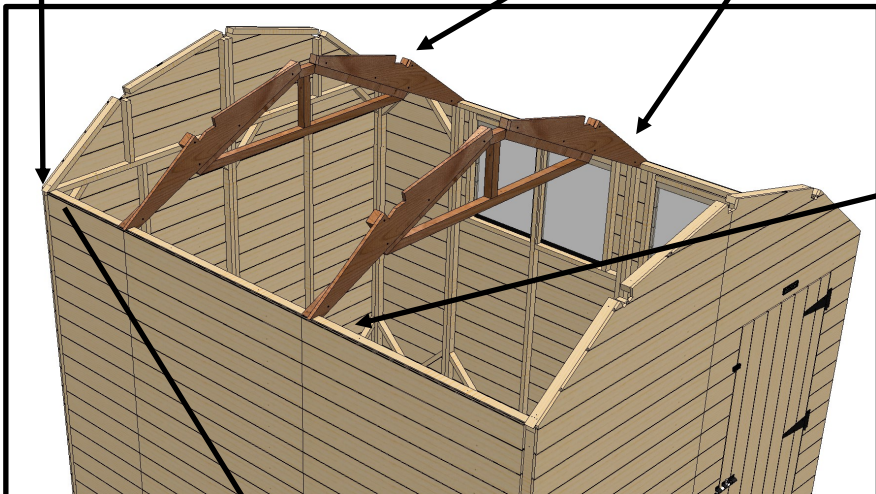

8x10 example

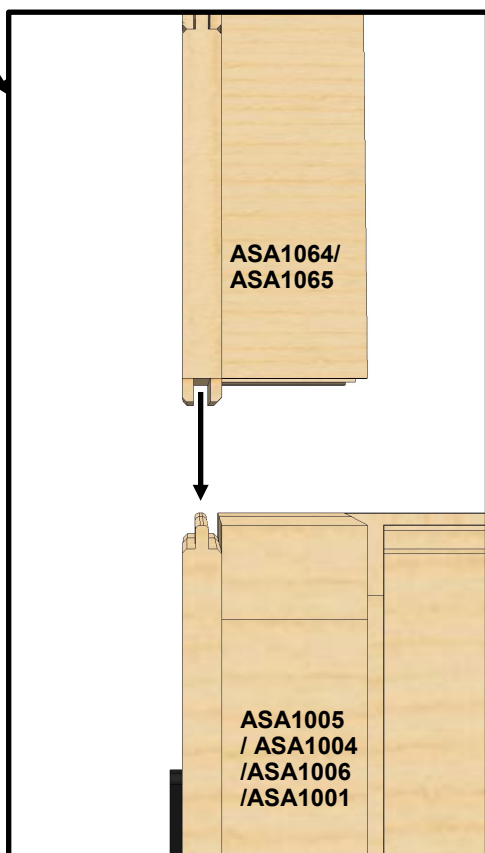
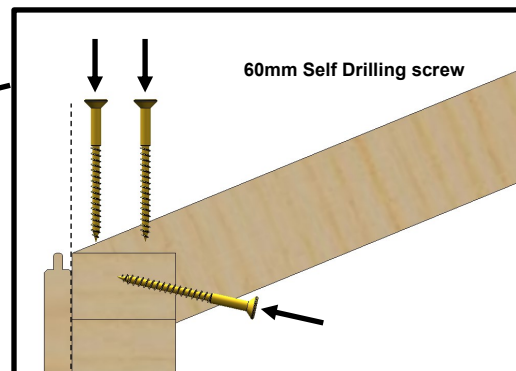

The cladding overhangs the Apex ASA1064/65, this means that when the ASA1064/65 sits on top of the ASA1001/04/05/06 the tongue can sit nicely in the groove.

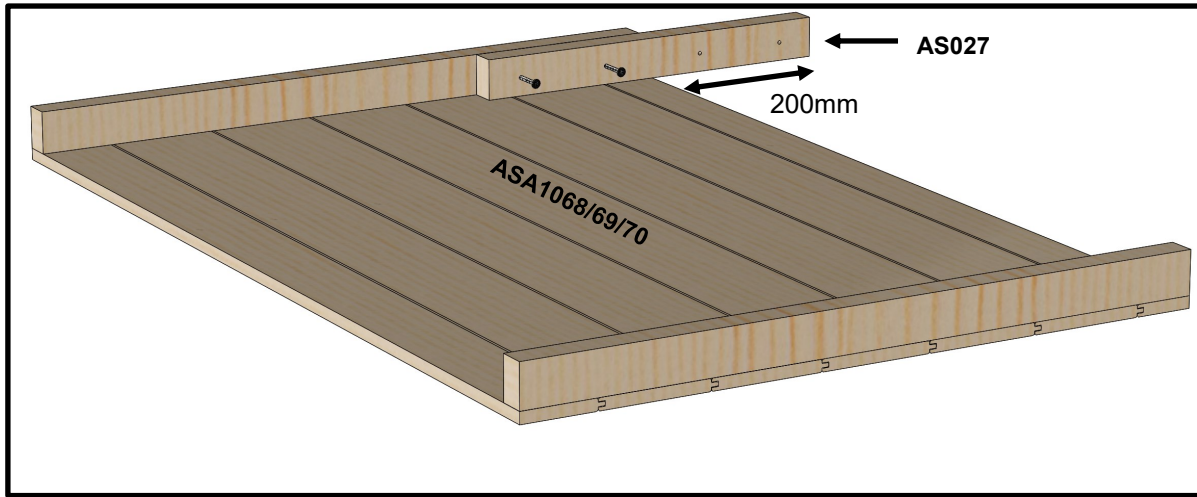

Attach the **AS027 Roof joiner** to the roof panels using 50mm screws. Remember to make 4mm pilot holes. Equally space the **AS027** so its overhanging 200mm from one side. You need to fix these on opposite ends of the roof sheet, one for the left slope and one for the right slope. Once you have attached this you can hook the roof onto the **ASA1028/29** Gable end and the **ASA1067** Truss. If panels start with a tongue or groove, they are not meant to interact with each other, roof panels simply butt up to each other.

NOTE: Please do not stand directly or put your whole body weight on the roof.

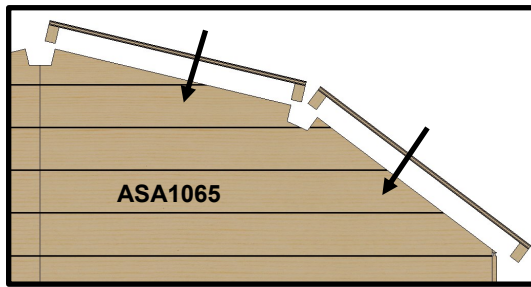
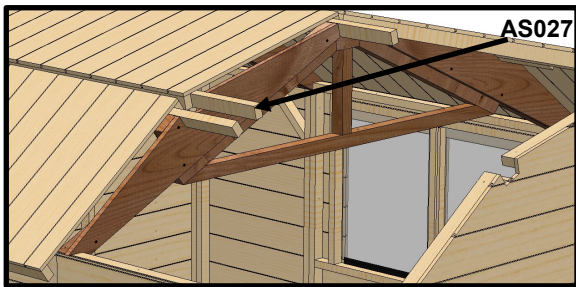

1. Screw on joining batons (50 mm screws and pilot drill)
2. Lift Panels onto roof
3. Even up overhand each end (44mm) and check its square.
4. Screw the joining baton to the other roof panel (50 mm screws and pilot drill)
5. Screw the ridge together using 60mm self drilling screws
6. Screw roof panels down using 35mm screws.

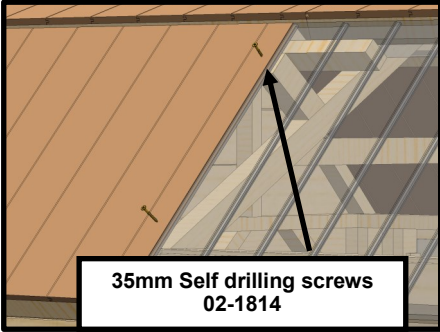

35mm Self drilling screws
02-1814

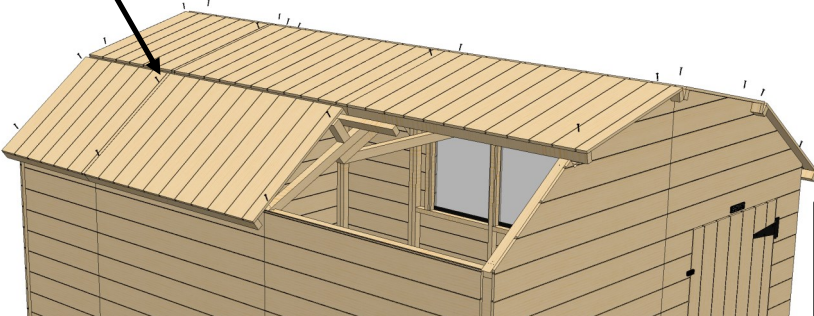

8x10 example

Carefully line up where you screw into the roof. You want to make sure you screw into the frame of the **ASA1067** and the frame of the **ASA1064/65 Gable tops**. The screws should be within 22mm from the middle of the roof and 44mm from the end of the roof

See the diagram to the right, this shows how the roof joint lines up with the side joint.

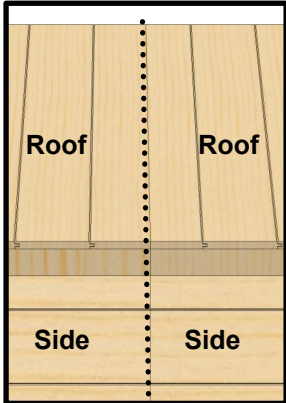

Roof Bracing

Now your roof is on and secure, its time to add the bracing (**AS206**) at either end. These will need 1 x 60mm screw at each side to secure it to the roof and the gable end.

See the photos below on where to fit them. You will have 2 supplied so one can go at the front and one can go at the back

Rear Gable

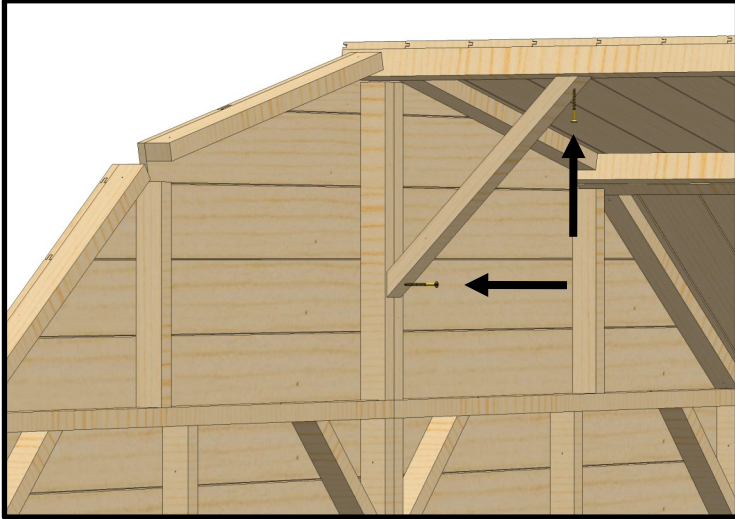

Front Gable

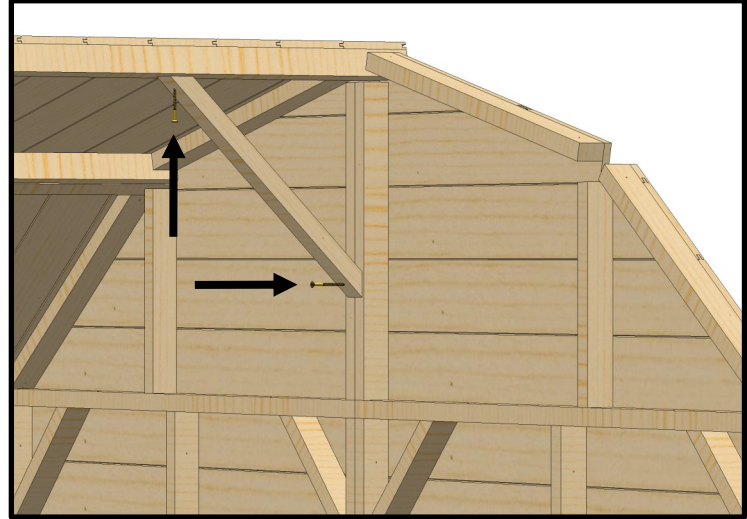

Rear Gable

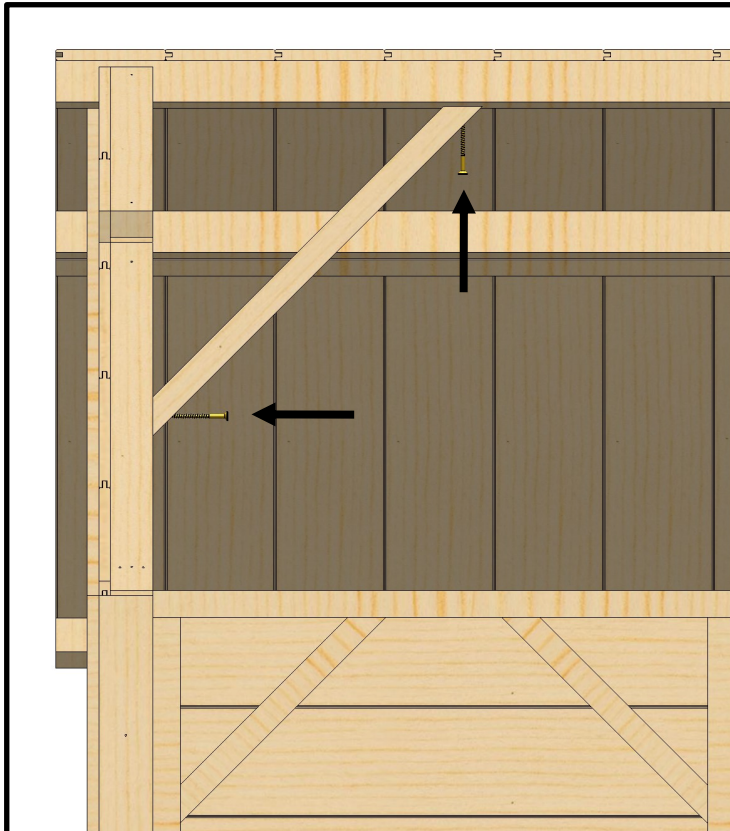

Front Gable

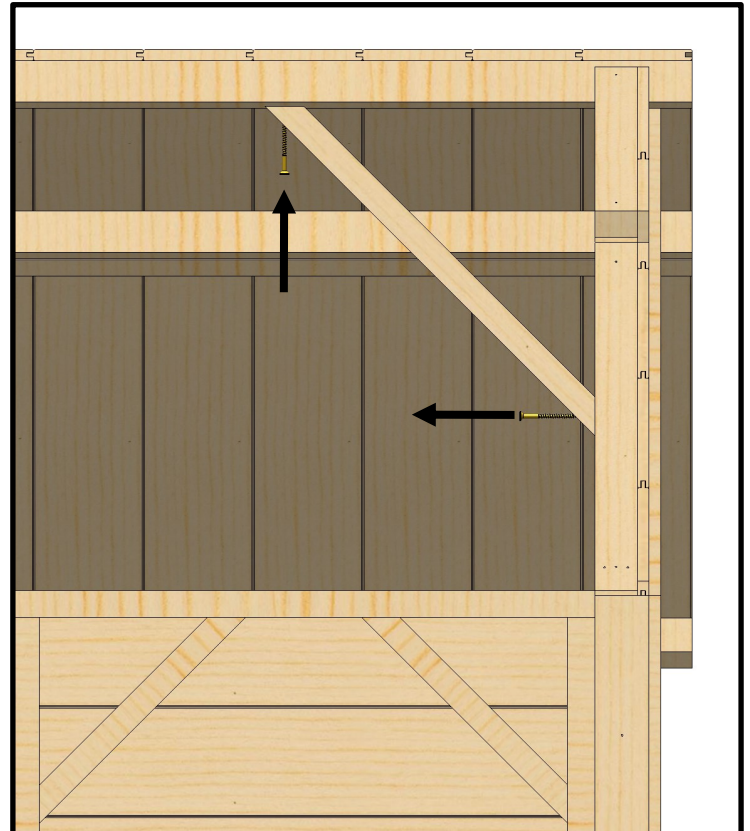

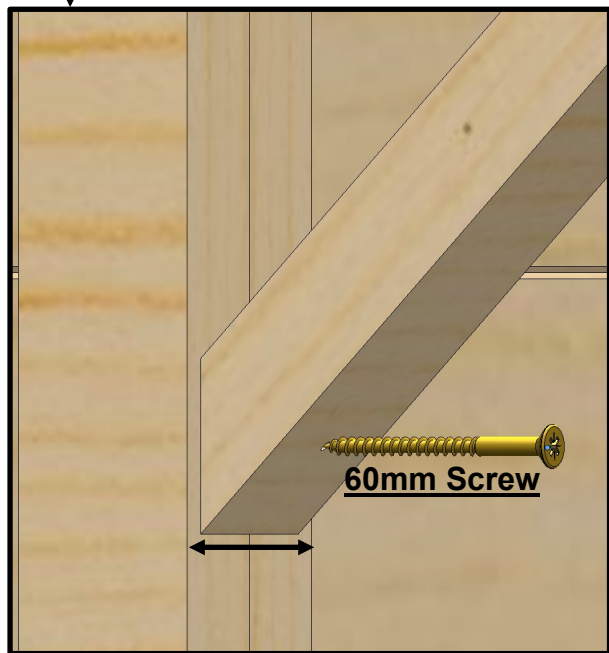
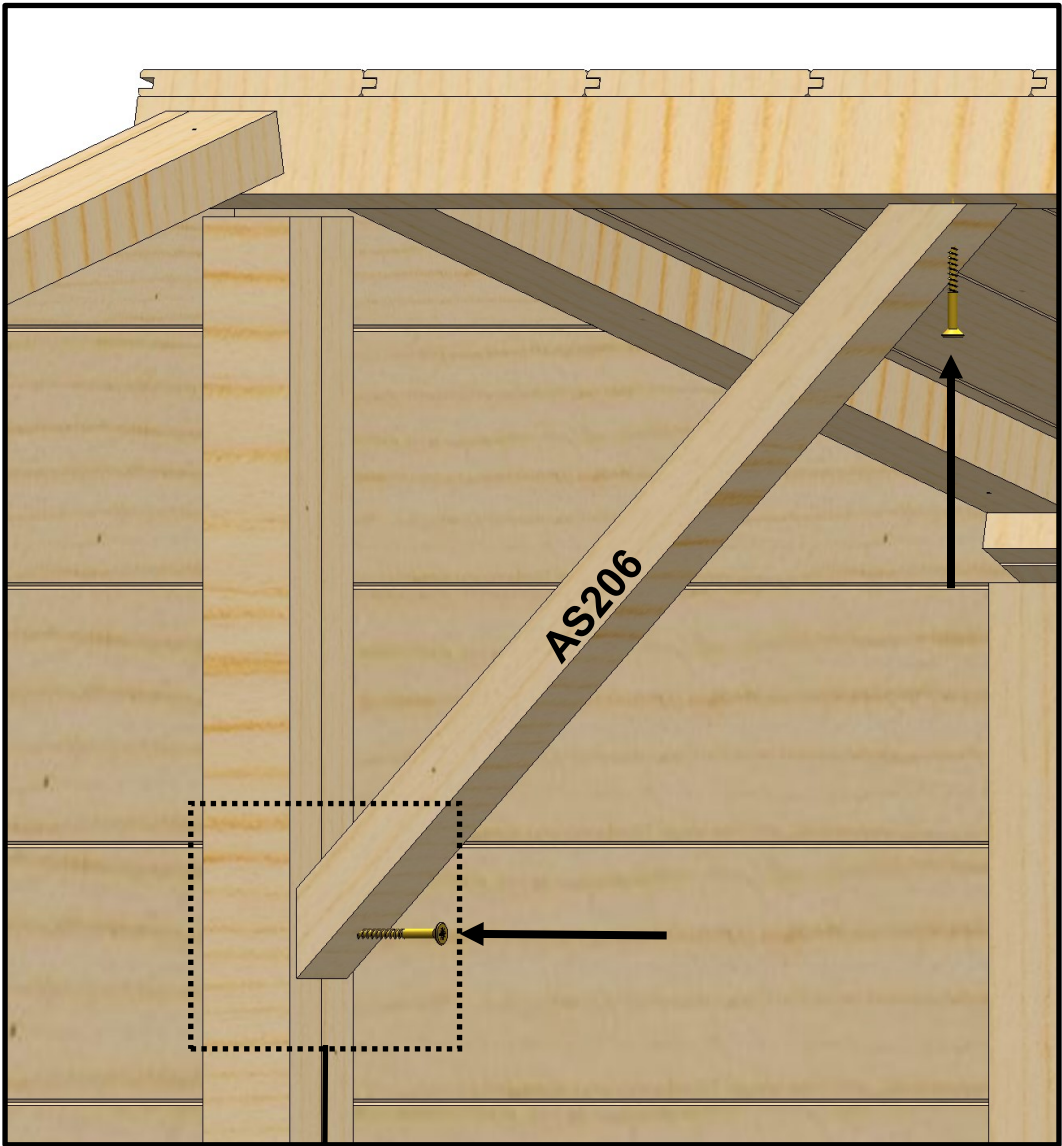

Equally spaced between the two batons

Felting

How to cut felt:

- Unroll out on the floor
- Mark correct length both sides of the roll using a tape measure.
- Use a straight edge as a ruler and cut with a Stanley knife
- Be cautious when cutting as if you cut one piece too big then the left overs will be too small.

Lengths to cut to	Felt 1m Wide	
	8x6	2107mm x3
	8x8	2707mm x3
	8x10	3307mm x3
	8x12	3907mm x3
	8x14	4507mm x3



Felt Clout
02-1675

Once you have your felt cut to the correct length its best to roll it back up and place the roll onto the roof and then roll it back across the roof. Once its rolled out, space it out evenly so that it overhangs 50mm evenly over each gable end and around 2mm at the eaves of the roof. Now its in the correct position, place a Felt clout at each top edge to stop it from sliding. Pull it down so its nice and flat and begin to tac at the eaves.

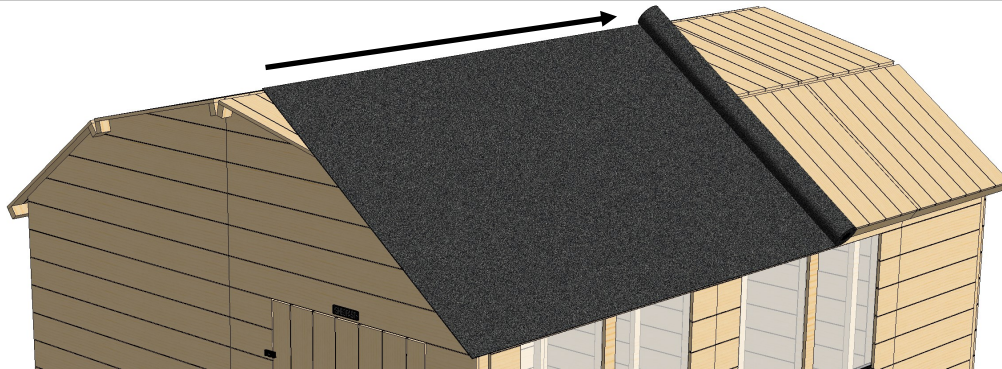

Felt clout paced at the top (each side) to stop it from sliding down. Be careful to not place the tac too close to the edge or you could run the risk of damaging the cladding when hammering down the tac. You only need two or three felt clouts along the top as the next piece will overlap and be fully nailed down.

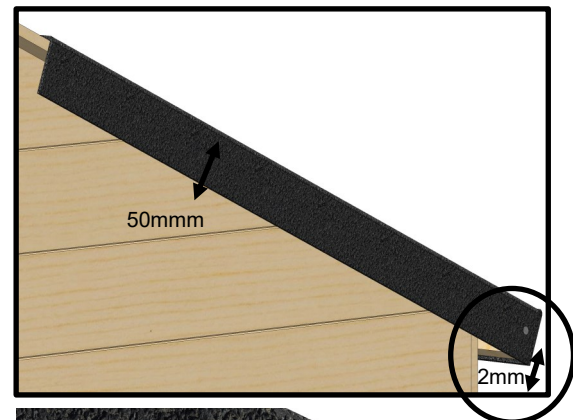

The felt should overhang slightly by about 2mm. It should not be tucked under or nailed 'up'. Also overhand the end by 50mm

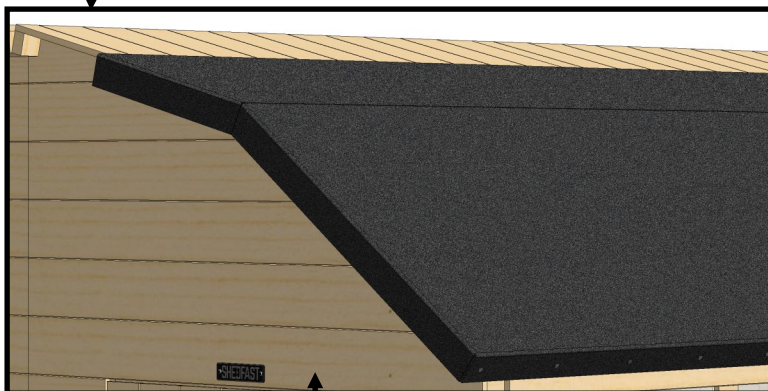

Repeat this step for the other side of the roof before you put the top piece on.

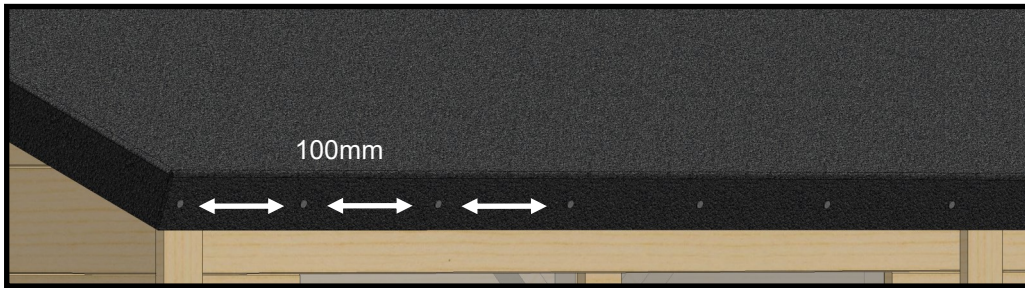

Tack the felt to the eaves, space the clouts approximately every 100mm. Ensure the felt overlaps the bottom roof baton by about 2mm to allow water to drip away from the

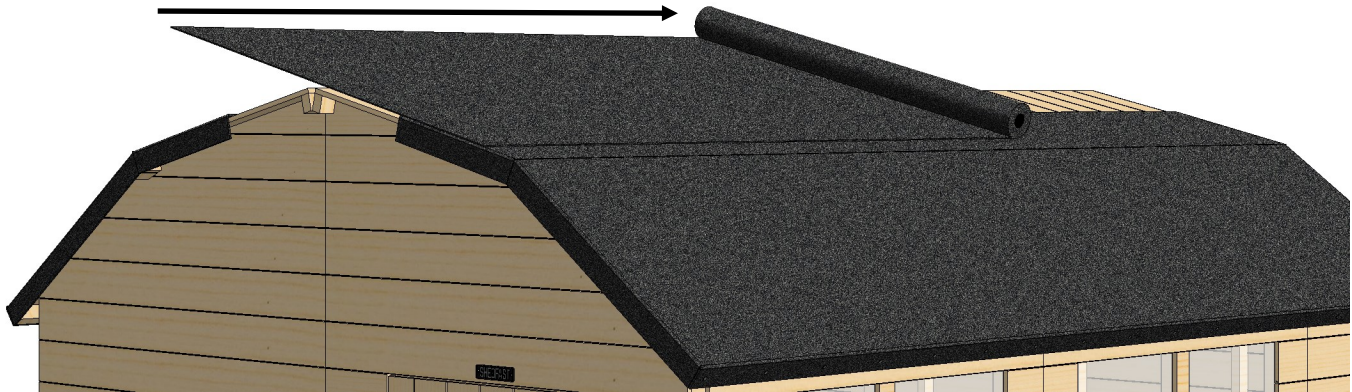

Cut your 1m felt to the correct length and roll that out across the top. Evenly space it over each side and get your 50mm overhang at the front and back as you have done previously. Place a felt clout every 100mm or so.

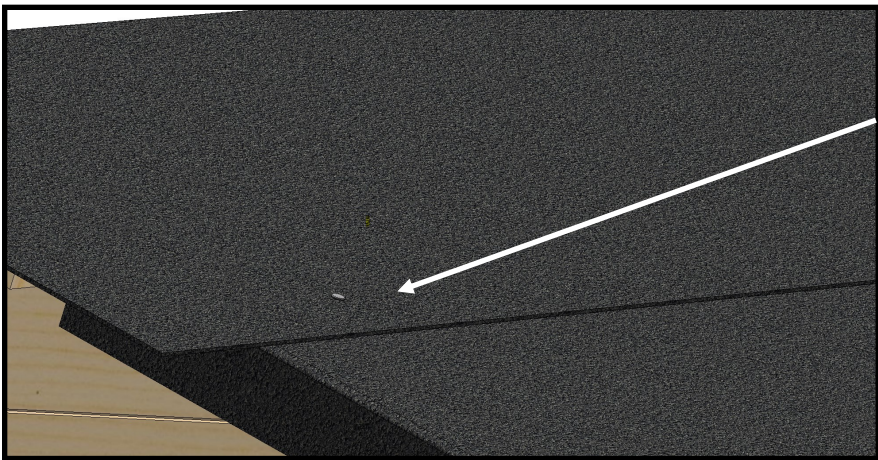

Put a clout in to stop the roof felt from sliding. Pull the felt tight on the other side before you put the clout in. This makes sure it is nice and flat to the roof. Do this on each side before putting all of the clouts in. Again, be careful to not place the clout too close to the edge or you could run the risk of damaging the cladding when hammering down the clout.

The sheets of felt should overlap by a minimum of 100mm. This is to ensure no water can blow through the gap and get to the wood below.

Like you did with the piece of felt below, tack down with clouts approximately every 100mm .

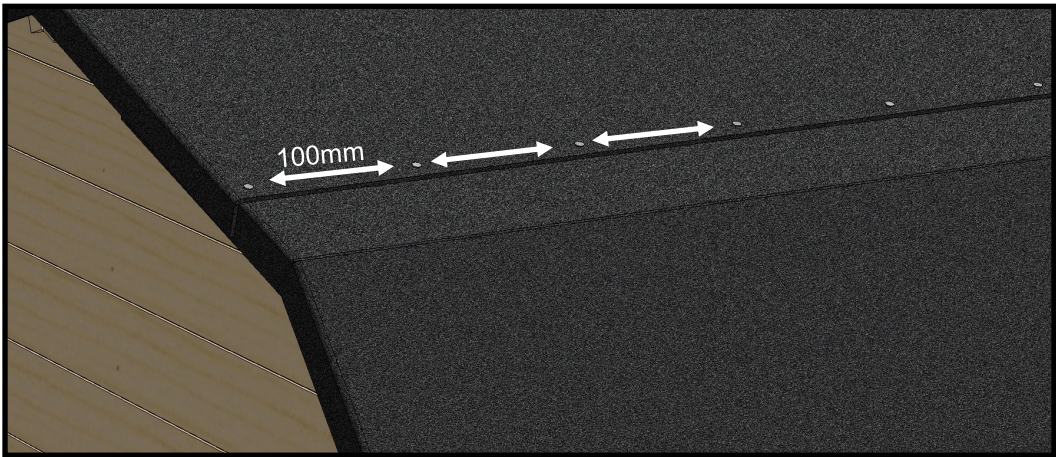

NOTE:
Please do not stand directly or put your whole body weight on the roof.

Facias and Capping

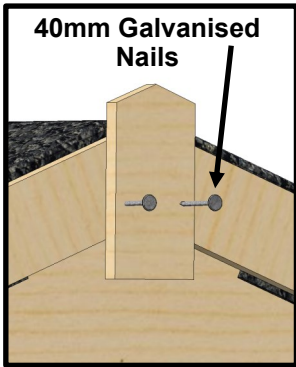
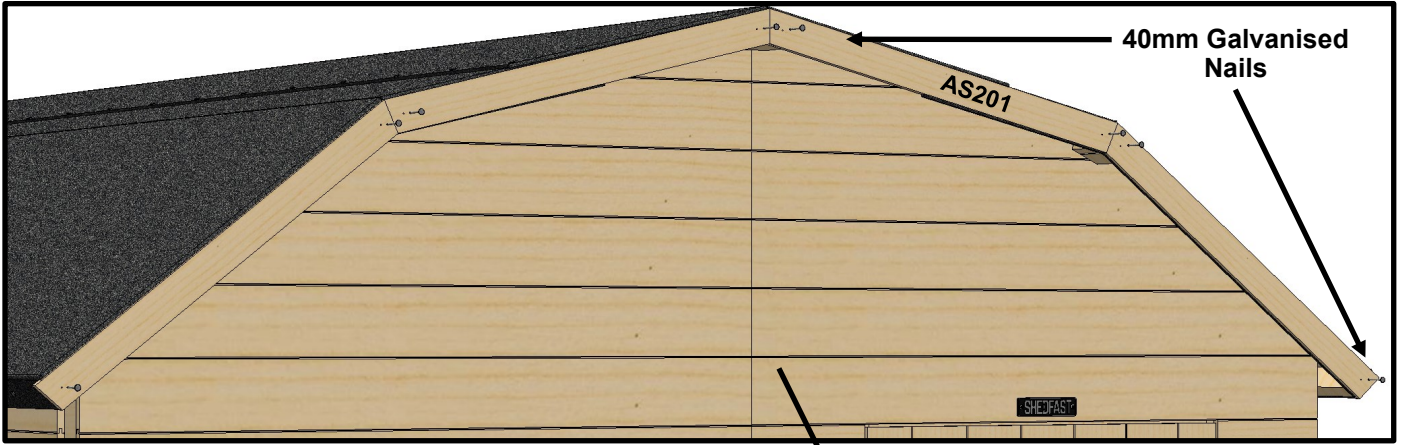

Put in 3 x 40mm Galvanised Nails in each AS024 strip.
One in the top, middle and bottom.

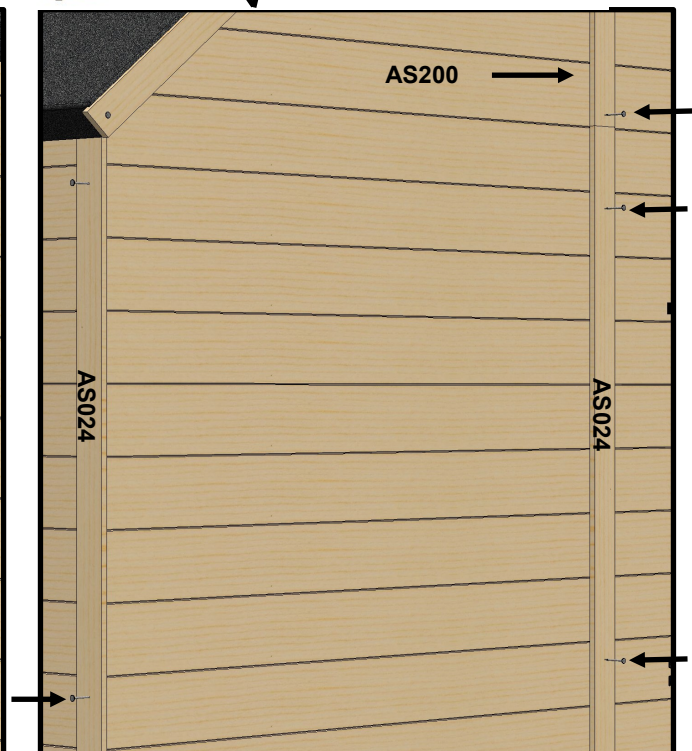
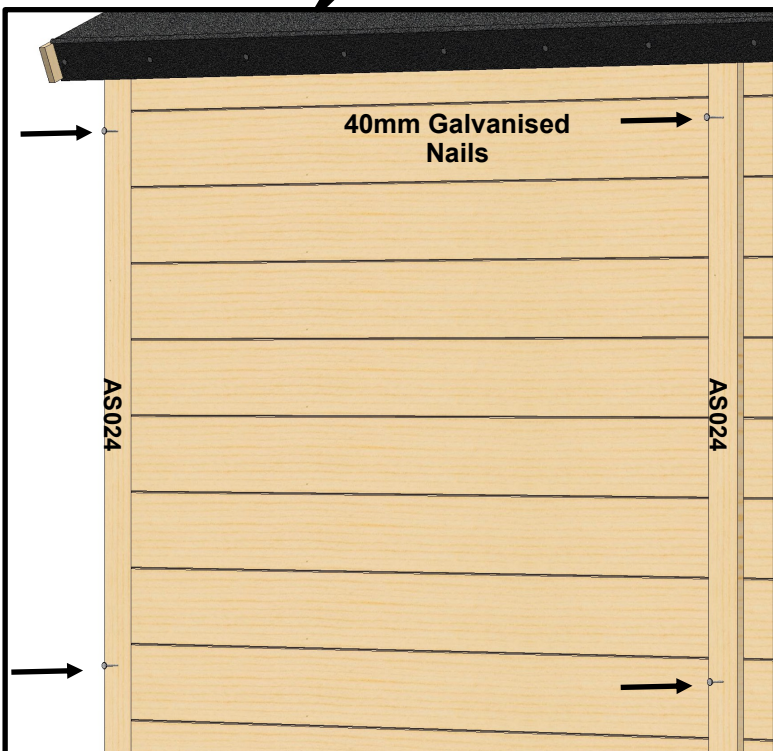
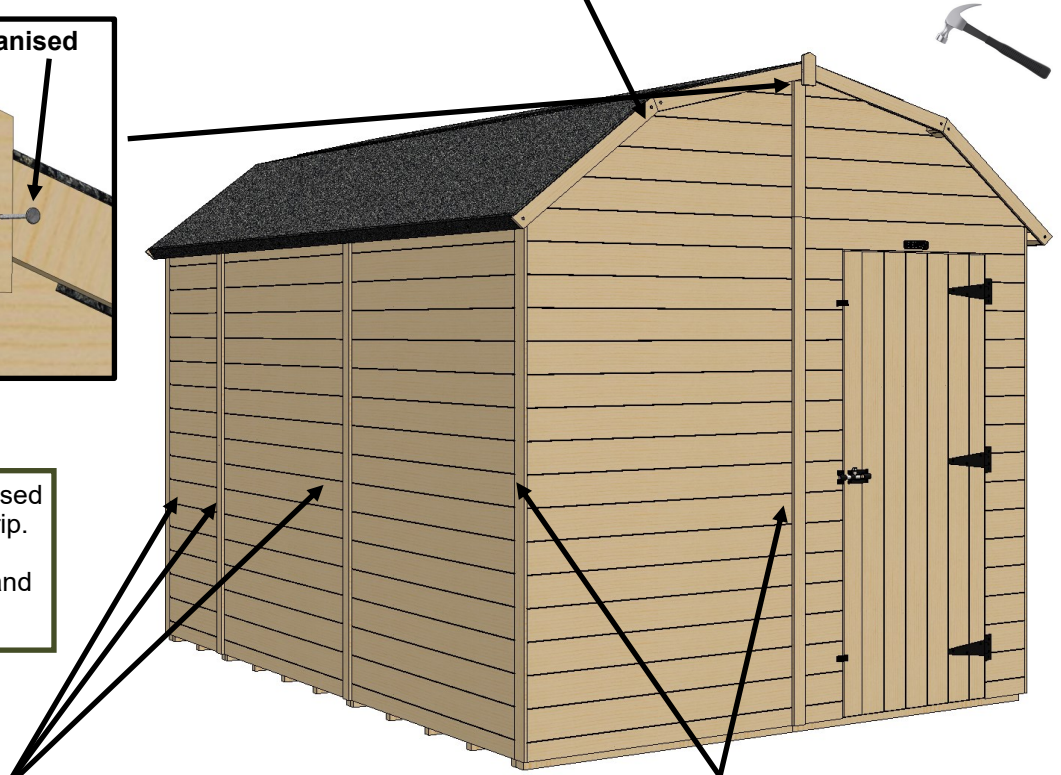

Fixing the sides to the floor

Now you have the roof fixed in position its now time to secure the sides to the floor. We do this last so that it is easier to square the roof up

Make sure the sides are equally spaced out from the floor (approx. 5mm from each side) and then put in your **60mm Screw 02-5001**

Place a screw down approximately every 2ft along the front, back and sides.

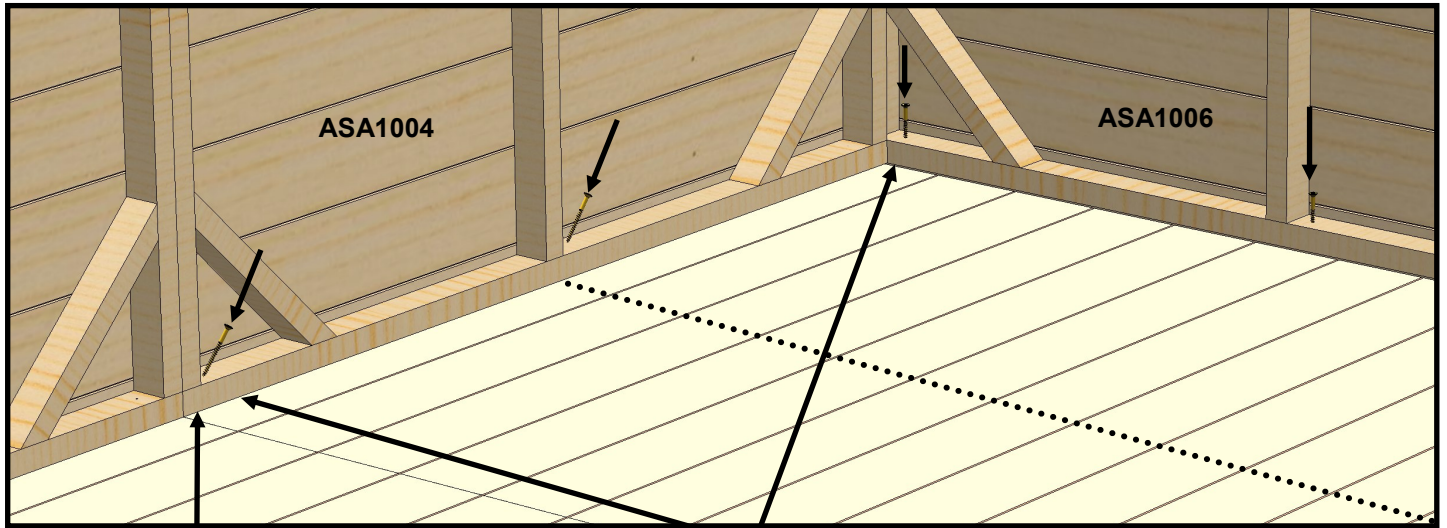

You will only need one screw at each joint

Some screws may need to be angled to catch the floor joists below.

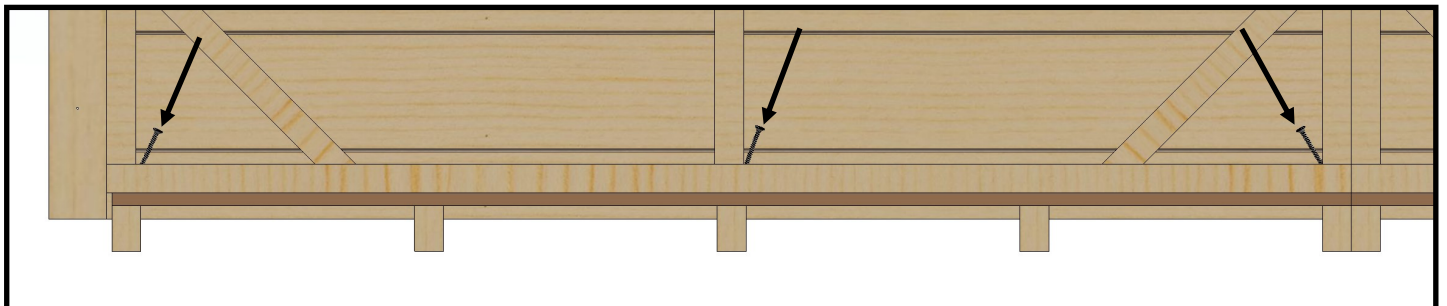

You can use the nails on the floor boards to see where the baton is underneath. Line your screws up with these nails when fixing the sides down to the floor

Shelving

On the 8ft Barn, you will receive 2 x 4ft long shelves (**ASA1072**) that will go across the rear end of the barn.

They are secured to the sides of the shed by sitting them on top of the **AS015** which means you can have the shelf at any desired height.

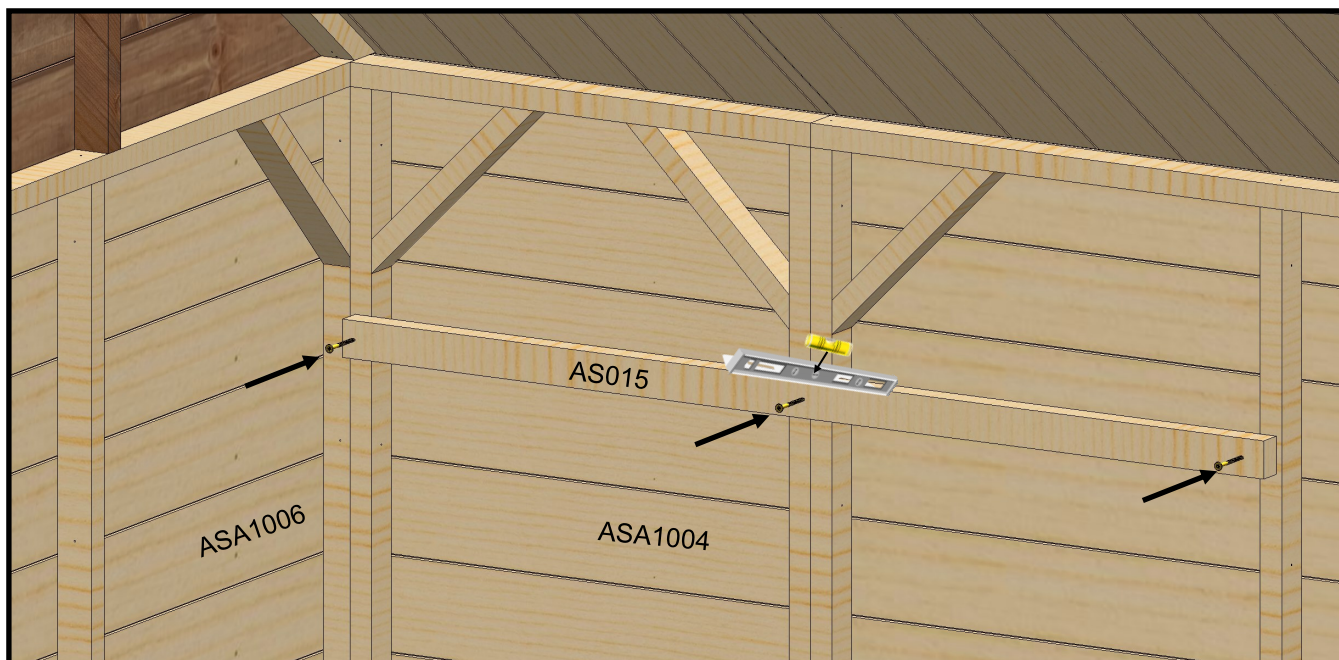

Use a spirit level to ensure that your **AS015** is level. Now, attach your **AS015** to the side panels by using 60mm screws to screw into the vertical joists. Repeat this on the opposite side of the shed.

Now you have the supports in place, it is time to built your shelf up. Lay your **ASA1072** shelf onto the ground so you can use the provided **AS015** and 60mm screws to attach the two shelves together. Use 3 x 60mm on each **AS015** and equally space them over the joins of the shelf See the diagram below. **NOTE:** when putting two shelves together, the tongue and groove **don't** need to match.

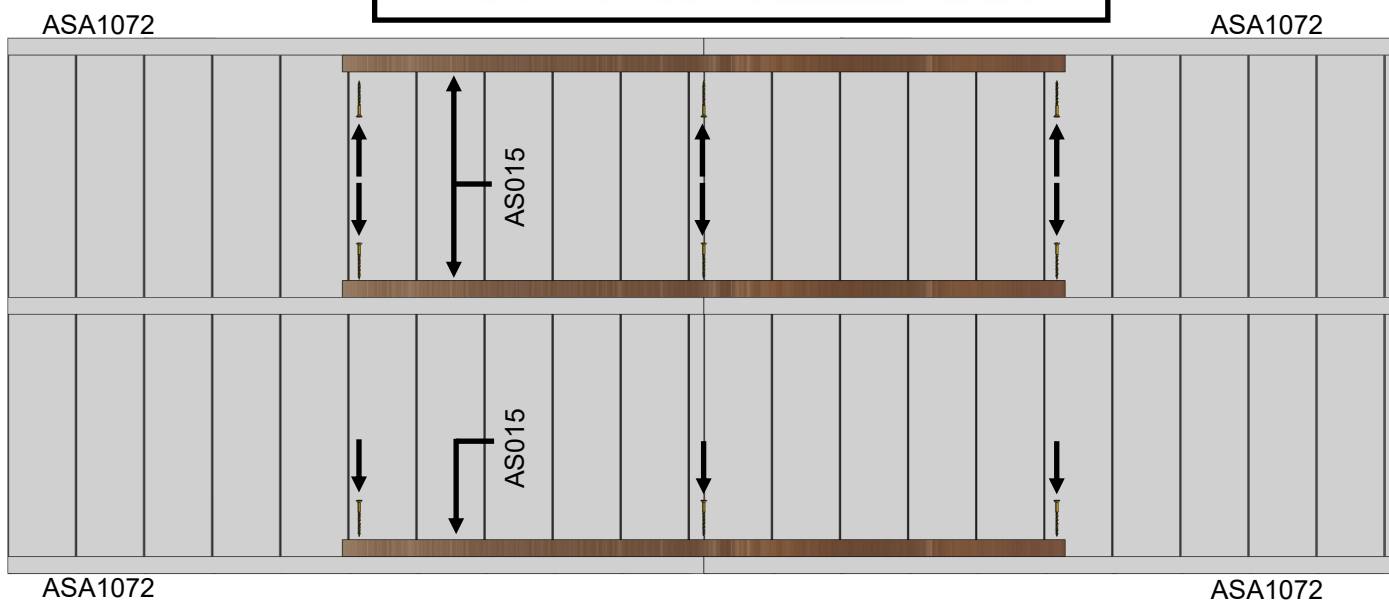

Now that your shelf is assembled and connected together, you can now offer it up and sit it on the AS015 batons that you previously attached to your sides. The shelves basically just sit on top of these and are secured using 35mm Screws. Once it is in the position you want it in, you need to attach the diagonal tube support (EV0350M) to support the middle underside.

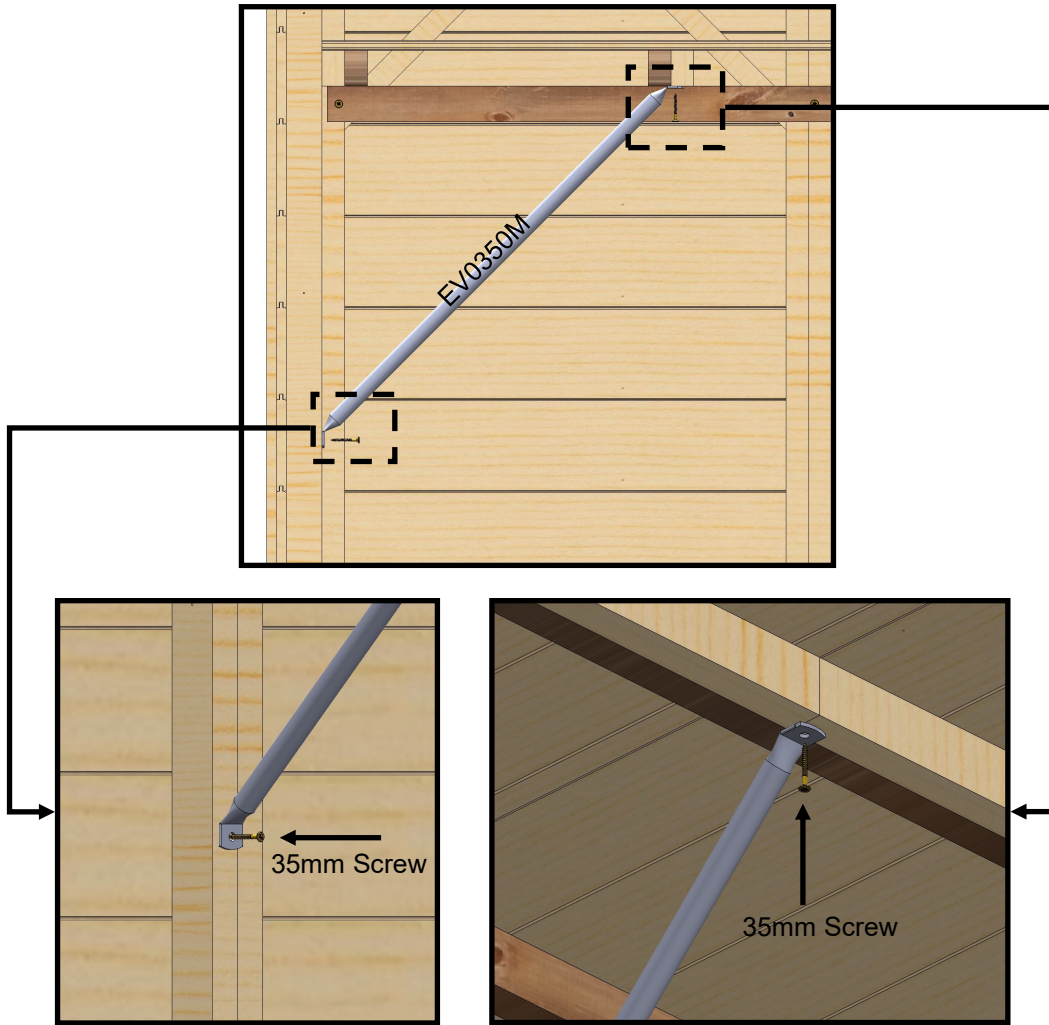

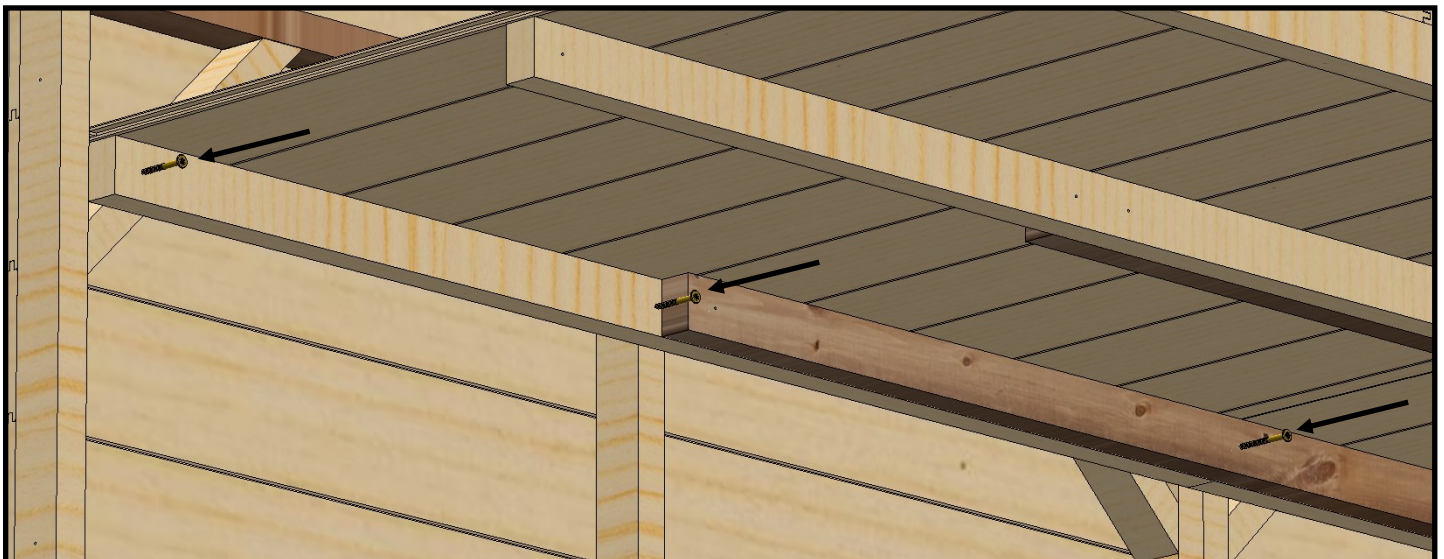

You can now secure the shelf to the rear gable of the shed. Screw the 60mm screws through the horizontal baton of the shelf into the vertical batons of the rear gable. Make sure to do this across the 8ft length of the shelf.





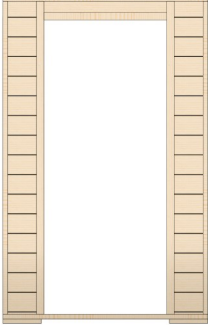

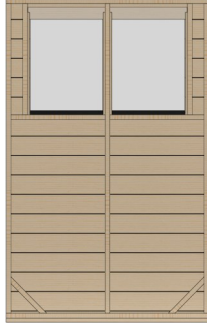
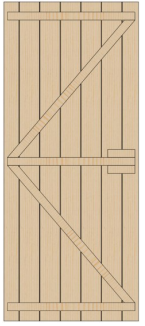

Standard Product Tables



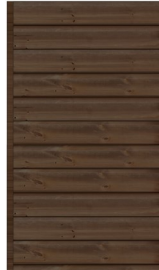
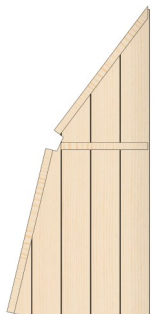
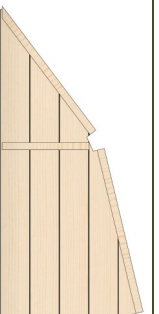

Side Panels

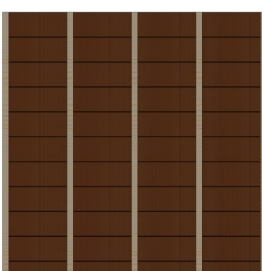

	ASA1004 2ft Panel 600x1856	ASA1005 Single Door Panel 1200x1856	ASA1006 4ft Panel 1200x1856	ASA1011 4ft Window Panel 1200x1856	ASA1008 Single Door 740x1751
					
8x6	2	1	3	1	1
8x8	0		4	2	
8x10	2		5	2	
8x12	0		6	3	
8x14	2		6	3	

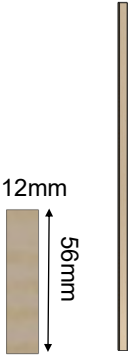
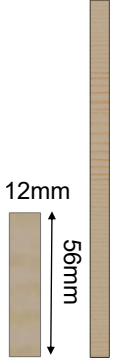
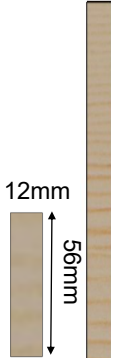
Roofs

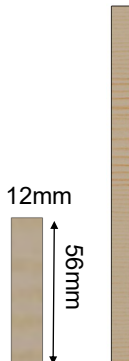
	ASA1068 8x2 Barn Roof 700x700	ASA1069 Barn Roof 713x1300	ASA1070 Barn Infill 700x1200	ASA1065 8ft Barn Left 545x1200	ASA1064 8ft Barn Right 545x1200	ASA1067 8ft Barn Truss
						
8x6	4	4		2	2	1
8x8	0	8	0			1
8x10	4	4	4			2
8x12	0	8	4			2
8x14	4	4	8			2

	ASA1023 4x4 Floor 1195x1195	ASA1026 4x2 Floor 600x1195	AS1072 Rear Shelf 888x1155
			
8x6	2	2	2
8x8	4	0	
8x10	4	2	
8x12	6	0	
8x14	6	2	

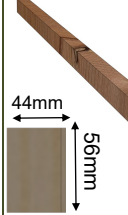
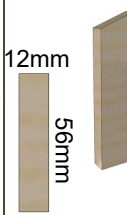
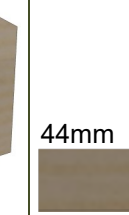
	AS024 Trim (1876mm)	AS070 Fa-cia (1362mm)	8ft gable trim (500mm)	ASA1071 8ft Truss Arm	AS200 12x56 Trim (502mm)	AS015 Framing 44x28 (1200mm)
						
8x6	6	4	2	2	2	5
8x8	8			2		
8x10	10			4		
8x12	10			4		
8x14	10			4		

	AS027 Roof Join-ers (400mm)	AS041X2 Floor Ex-tenders (1195mm)	AS305 Fini-al	AS206 Roof Brace (480mm)	EV0350M Tubular Support
					
8x6	6	4	2	2	1
8x8	6				
8x10	12				
8x12	12				
8x14	18				

	AS306 Name Badge	AS302 Tee Hinges	AS303 Pad bolt	AS304 Turn Buttons
				
8x6	1	3	1	2
8x8				
8x10				
8x12				
8x14				

Felt Length	4.1m	5.4m	6.6m
Felt Width	1m Wide	1m Wide	1m Wide
8x6	0	0	1
8x8	2	0	0
8x10	1	0	1
8x12	0	1	1
8x14	1	2	0

Notes

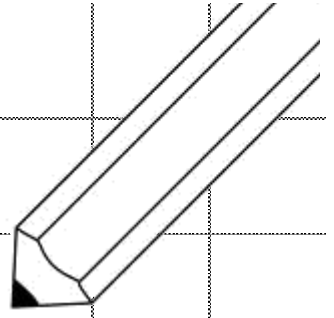

8ft WIDE APEX



Unpacking Pallet

The first thing you need to do is carefully unpack the pallet. Each panel is screwed to the diagonals at the top and bottom. Remove each panel, one at a time, by unscrewing the screws at the top and bottom. Take the panel off the pallet and place it somewhere safe.

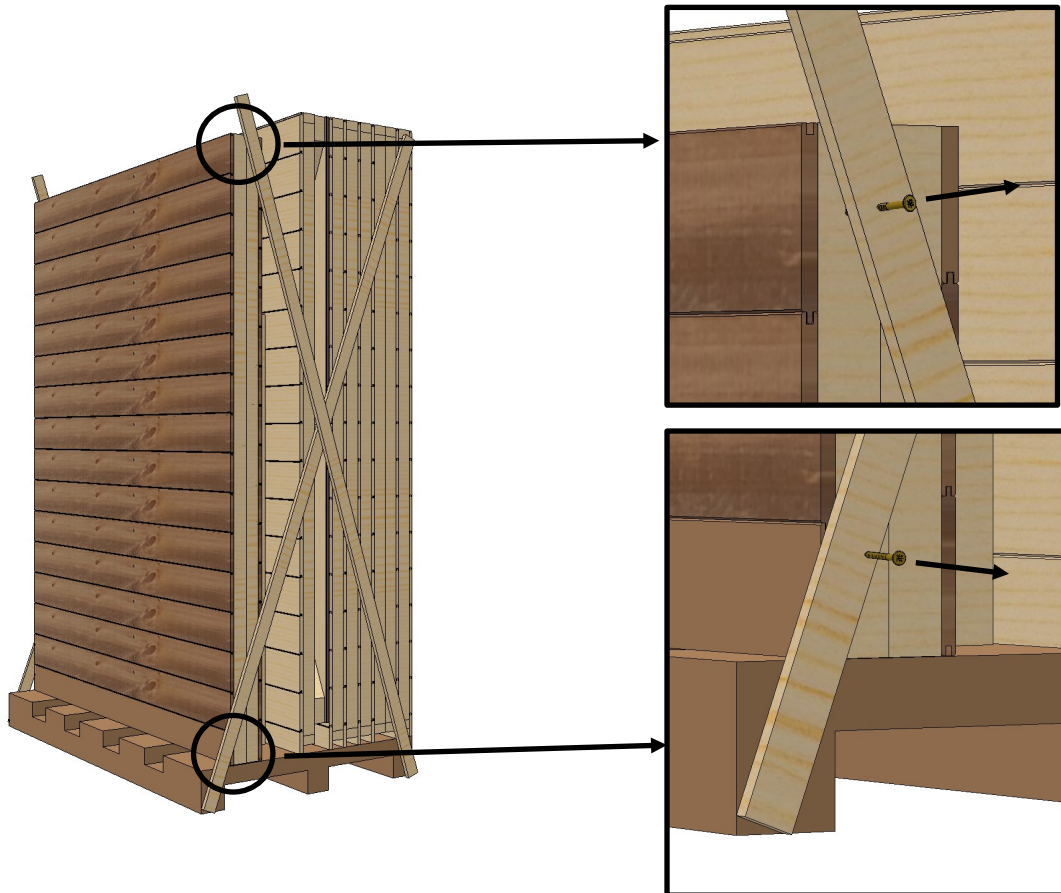

SHEDEFAST

www.greenhousepeople.co.uk

Call us on 01782 385400

The Greenhouse People Ltd, Unit 19 Blythe Park, Cresswell, Stoke-on-Trent, Staffordshire, ST11 9RD